

VIPA System 300S

SPEED7 - PS | 307-1FB70 | Manual

HB140E_PS | RE_307-1FB70 | Rev. 13/43

October 2013

Copyright © VIPA GmbH. All Rights Reserved.

This document contains proprietary information of VIPA and is not to be disclosed or used except in accordance with applicable agreements.

This material is protected by the copyright laws. It may not be reproduced, distributed, or altered in any fashion by any entity (either internal or external to VIPA), except in accordance with applicable agreements, contracts or licensing, without the express written consent of VIPA and the business management owner of the material.

For permission to reproduce or distribute, please contact:
VIPA, Gesellschaft für Visualisierung und Prozessautomatisierung mbH
Ohmstraße 4, D-91074 Herzogenaurach, Germany
Tel.: +49 (91 32) 744 -0
Fax.: +49 9132 744 1864
EMail: info@vipa.de
<http://www.vipa.com>

Note

Every effort has been made to ensure that the information contained in this document was complete and accurate at the time of publishing. Nevertheless, the authors retain the right to modify the information. This customer document describes all the hardware units and functions known at the present time. Descriptions may be included for units which are not present at the customer site. The exact scope of delivery is described in the respective purchase contract.

CE Conformity Declaration

Hereby, VIPA GmbH declares that the products and systems are in compliance with the essential requirements and other relevant provisions.

Conformity is indicated by the CE marking affixed to the product.

Conformity Information

For more information regarding CE marking and Declaration of Conformity (DoC), please contact your local VIPA customer service organization.

Trademarks

VIPA, SLIO, System 100V, System 200V, System 300V, System 300S, System 400V, System 500S and Commander Compact are registered trademarks of VIPA Gesellschaft für Visualisierung und Prozessautomatisierung mbH.

SPEED7 is a registered trademark of profichip GmbH.

SIMATIC, STEP, SINEC, TIA Portal, S7-300 and S7-400 are registered trademarks of Siemens AG.

Microsoft und Windows are registered trademarks of Microsoft Inc., USA.

Portable Document Format (PDF) and Postscript are registered trademarks of Adobe Systems, Inc.

All other trademarks, logos and service or product marks specified herein are owned by their respective companies.

Information product support

Contact your local VIPA Customer Service Organization representative if you wish to report errors or questions regarding the contents of this document. If you are unable to locate a customer service center, contact VIPA as follows:

VIPA GmbH, Ohmstraße 4, 91074 Herzogenaurach, Germany

Telefax: +49 9132 744 1204
EMail: documentation@vipa.de

Technical support

Contact your local VIPA Customer Service Organization representative if you encounter problems with the product or have questions regarding the product. If you are unable to locate a customer service center, contact VIPA as follows:

VIPA GmbH, Ohmstraße 4, 91074 Herzogenaurach, Germany

Telephone: +49 9132 744 1150 (Hotline)
EMail: support@vipa.de

Contents

This manual describes the Co Power Supply PS 307S_Co for the CPU 317S SPEED7 from VIPA. Here you may find every information for commissioning and operation.

About this manual	1
Safety information	2
Chapter 1 Assembly and installation guidelines.....	1-1
Overview	1-2
Installation dimensions	1-3
Assembly SPEED-Bus	1-4
Cabling.....	1-7
Installation guidelines	1-8
General data	1-11
Chapter 2 Hardware description and deployment	2-1
Safety Information for Users.....	2-2
Properties.....	2-3
Structure	2-4
Technical data.....	2-5

About this manual

Objective and contents

This manual describes the Co Power Supply for the CPU 317S SPEED7 from VIPA. It contains a description of the construction and usage together with the CPU 317S.

This manual is part of the documentation package with order number VIPA HB140E_PS and relevant for:

Product	Order number	as of HW state
PS 307S_Co	VIPA 307-1FB70	01

Target audience

The manual is targeted at users who have a background in automation technology.

Structure of the manual

The manual consists of chapters. Every chapter provides a self-contained description of a specific topic.

Guide to the document

The following guides are available in the manual:

- an overall table of contents at the beginning of the manual
- an overview of the topics for every chapter
- an index at the end of the manual.

Availability

The manual is available in:

- printed form, on paper
- in electronic form as PDF-file (Adobe Acrobat Reader)

Icons Headings

Important passages in the text are highlighted by following icons and headings:



Danger!

Immediate or likely danger.
Personal injury is possible.



Attention!

Damages to property is likely if these warnings are not heeded.



Note!

Supplementary information and useful tips.

Safety information

Applications conforming with specifications

The Co Power Supply is constructed and produced for:

- the common deployment with the CPU 317S SPEED7 from VIPA
- communication and process control
- general control and automation applications
- industrial applications
- operation within the environmental conditions specified in the technical data
- installation into a cubicle



Danger!

This device is not certified for applications in

- in explosive environments (EX-zone)

Documentation

The manual must be available to all personnel in the

- project design department
- installation department
- commissioning
- operation



The following conditions must be met before using or commissioning the components described in this manual:

- Modification to the process control system should only be carried out when the system has been disconnected from power!
- Installation and modifications only by properly trained personnel
- The national rules and regulations of the respective country must be satisfied (installation, safety, EMC ...)

Disposal

National rules and regulations apply to the disposal of the unit!

Chapter 1 Assembly and installation guidelines

Overview In this chapter you will find all information, required for the installation and the cabling of a PLC system with the components of the System 300 and the Co Power Supply.

Content	Topic	Page
	Chapter 1 Assembly and installation guidelines.....	1-1
	Overview	1-2
	Installation dimensions	1-3
	Assembly SPEED-Bus	1-4
	Cabling.....	1-7
	Installation guidelines.....	1-8
	General data	1-11

Overview

General

Depending upon the CPU type besides the serial standard bus there is additionally a parallel SPEED-Bus integrated to the CPU. There up to 10 modules of the SPEED-Bus periphery may be connected.

While the standard peripheral modules are plugged-in at the right side of the CPU, the SPEED-Bus peripheral modules are connected via a SPEED-Bus bus connector at the left side of the CPU.

VIPA delivers profile rails with integrated SPEED-Bus for 2, 6, or 10 SPEED-Bus peripheral modules with different lengths.

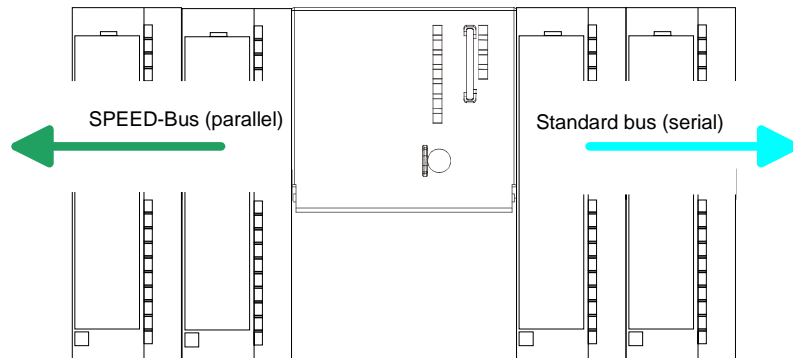

Serial Standard bus

The single modules are directly installed on a profile rail and connected via the backplane bus connector. Before installing the modules you have to clip the backplane bus connector to the module from the backside.

A backplane bus connector is scope of delivery of a peripheral module.

Parallel SPEED-Bus

With SPEED-Bus the bus connection happens via a SPEED-Bus rail integrated in the profile rail at the left side of the CPU. Due to the parallel SPEED-Bus not all slots must be occupied in sequence.

SLOT 1 for Co Power Supply PS 307S_Co

At SLOT 1 DCDC you may plug either a SPEED-Bus module or the Co Power Supply PS 307S_Co - exclusively with deployment of the CPU 317S.

Assembly possibilities

You may assemble the System 300 horizontally, vertically or lying.

horizontal assembly

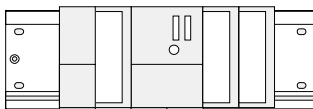

vertical assembly



lying assembly

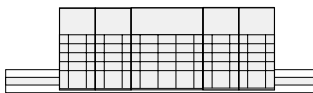

Please regard the allowed environment temperatures:

- horizontal assembly: from 0 to 60°C
- vertical assembly: from 0 to 40°C
- lying assembly: from 0 to 40°C

Installation dimensions

**Dimensions
basic enclosure**

1tier width (WxHxD) in mm: 40 x 125 x 120

Dimensions

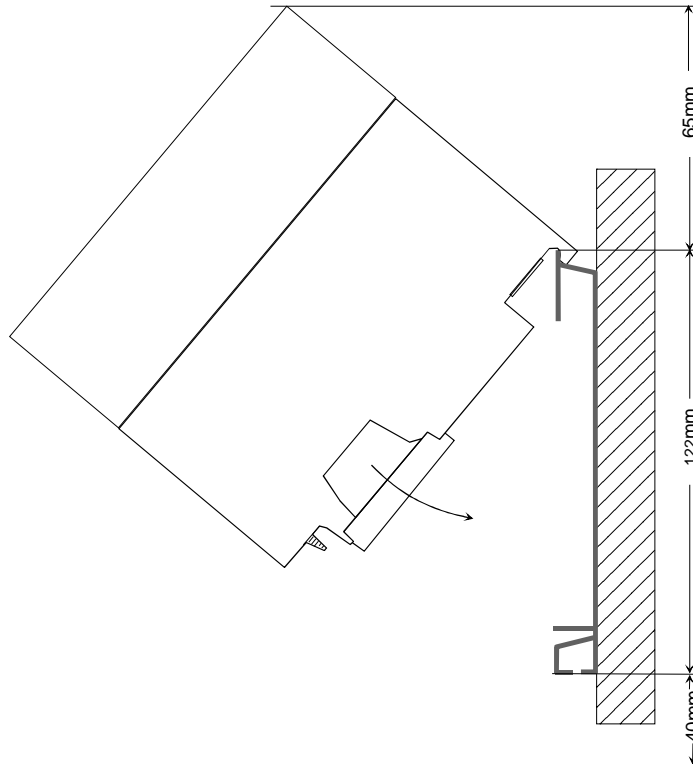

**Installation
dimensions**

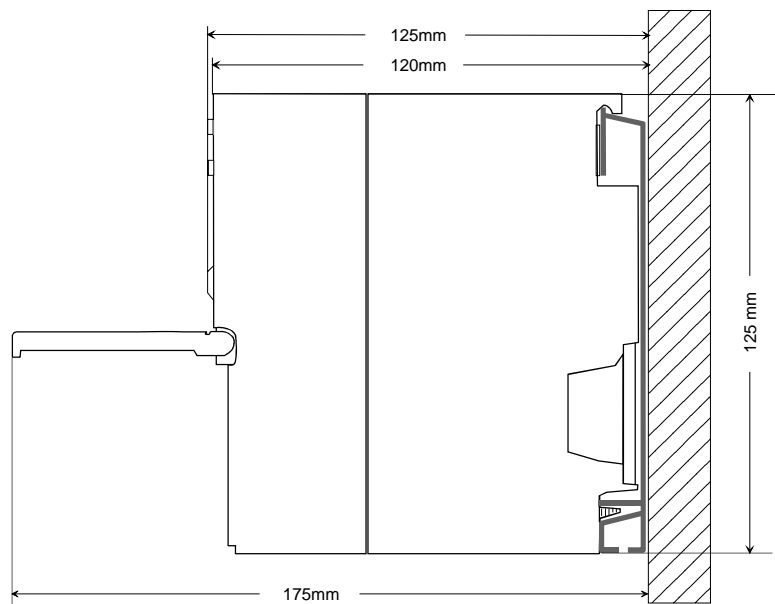

Assembly SPEED-Bus

Pre-manufactured SPEED-Bus profile rail

For the deployment of SPEED-Bus modules, a pre-manufactured SPEED-Bus rail is required. This is available mounted on a profile rail with 2, 6 or 10 extension plug-in locations.

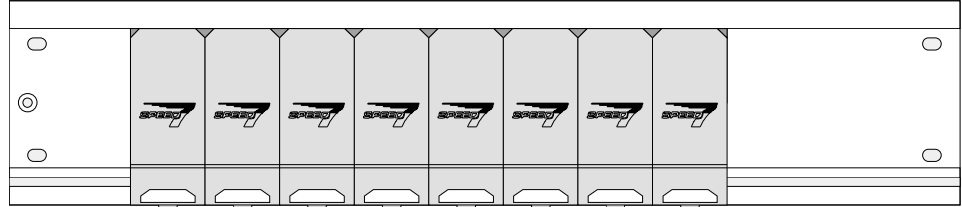

Installation of the profile rail

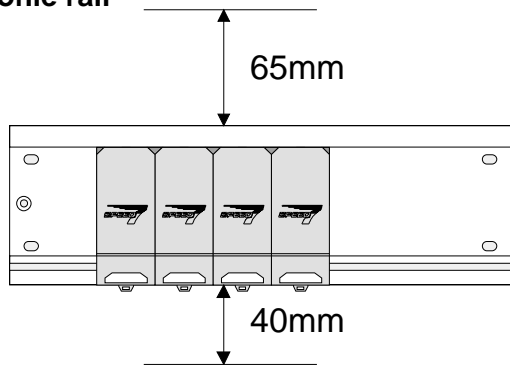

- Bolt the profile rail with the background (screw size: M6), so that you still have minimum 65mm space above and 40mm below the profile rail.
- Please look for a low-impedance connection between profile rail and background

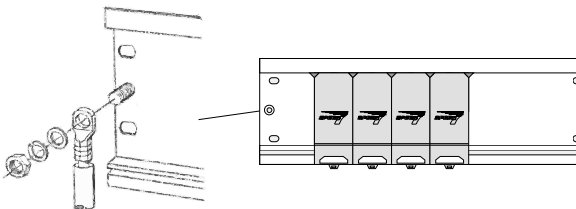

- Connect the profile rail with the protected earth conductor.
The minimum cross-section of the cable to the protected earth conductor has to be 10mm².

Profile rail

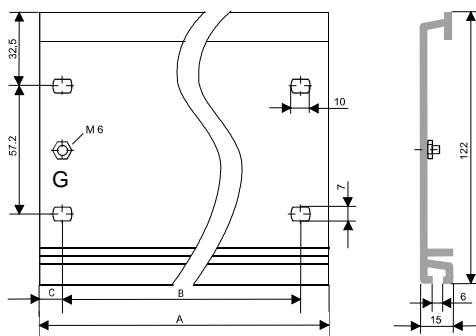

Order number	SPEED-Bus Slot	A	B	C
VIPA 390-1AB60	-	160mm	140mm	10mm
VIPA 390-1AE80	-	482mm	466mm	8,3mm
VIPA 390-1AF30	-	530mm	500mm	15mm
VIPA 390-1AJ30	-	830mm	800mm	15mm
VIPA 390-9BC00*	-	2000mm	-	15mm
VIPA 391-1AF10	2	530mm	500mm	15mm
VIPA 391-1AF30	6	530mm	500mm	15mm
VIPA 391-1AF50	10	530mm	500mm	15mm
VIPA 391-1AF80	16	830mm	800mm	15mm

* Unit pack 10 pieces

**Installation
SPEED-Bus-
Module**

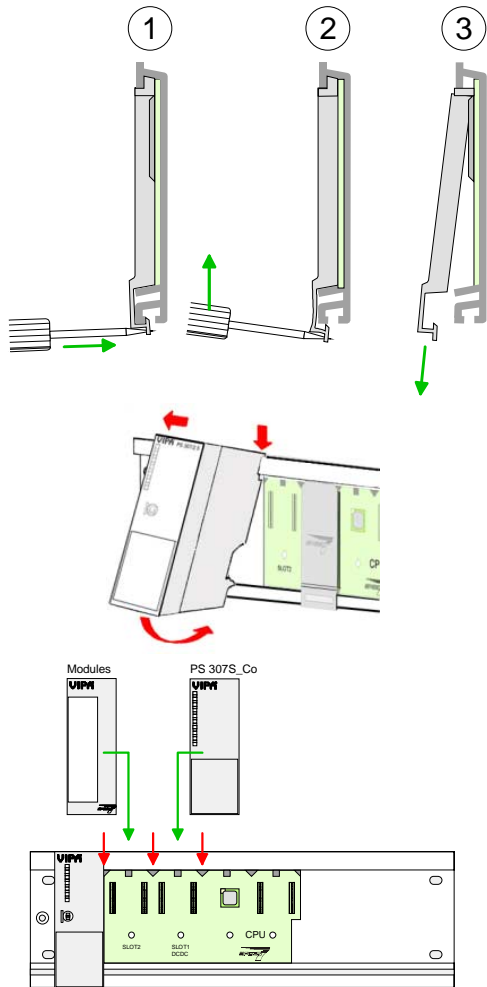

- Dismantle the according protection flaps of the SPEED-Bus plug-in locations with a screwdriver (open and pull down).
For the SPEED-Bus is a parallel bus, not all SPEED-Bus plug-in locations must be used in series. Leave the protection flap installed at an unused SPEED-Bus plug-in location.

- At deployment of a DC 24V power supply, install it at the shown position at the profile rail at the left side of the SPEED-Bus and push it to the left to the isolation bolt of the profile rail.
- Fix the power supply by screwing.

- To connect the SPEED-Bus modules, plug it between the triangular positioning helps to a plug-in location marked with "SLOT ..." and pull it down.
- Only the "SLOT1 DCDC" allows you to plug-in either a SPEED-Bus module or the Co Power Supply PS 307S_Co - exclusive together with the CPU 317S.
- Fix the modules by screwing.

**Installation CPU
without Standard-
Bus-Modules**

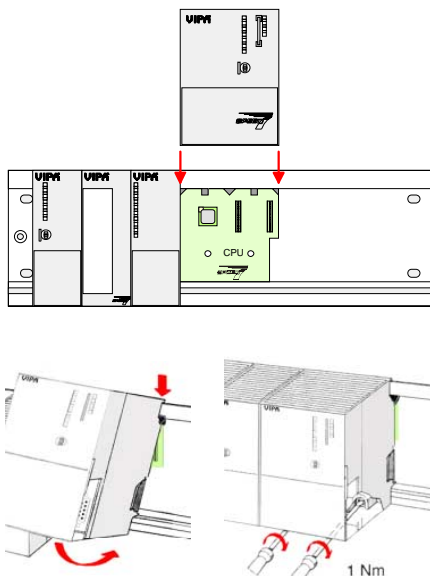

- To deploy the SPEED7-CPU exclusively at the SPEED-Bus, plug it between the triangular positioning helps to the plug-in location marked with "CPU SPEED7" and pull it down.
- Fix the CPU by screwing.

Please regard that only the CPU 31xS may be deployed at the SPEED-Bus!

Installation CPU
with Standard-Bus-
Modules

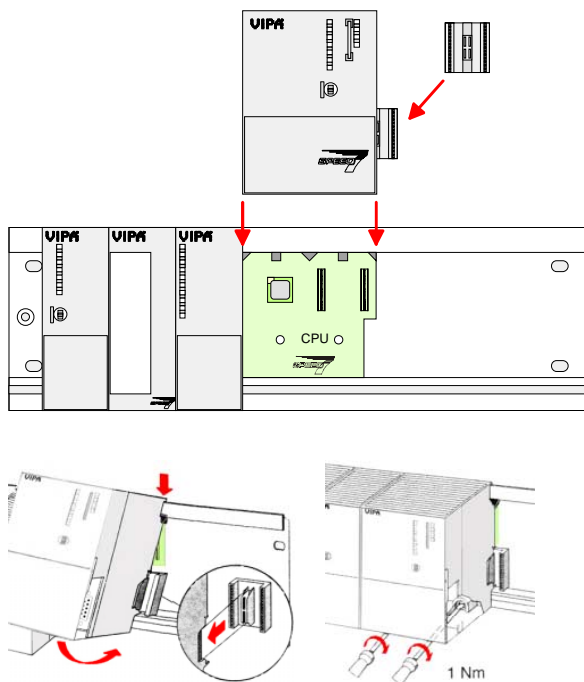

- If also standard modules shall be plugged, take a bus coupler and click it at the CPU from behind like shown in the picture.
- Plug the CPU between the triangular positioning helps to the plug-in location marked with "CPU SPEED7" and pull it down.
- Fix the CPU by screwing.

Installation
Standard-Bus-
Modules

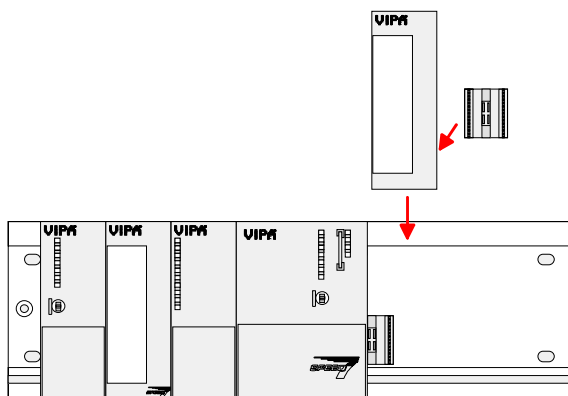

- Repeat this procedure with the peripheral modules, by clicking a backplane bus coupler, stick the module right from the modules you've already fixed, click it downwards and connect it with the backplane bus coupler of the last module and bolt it.



Danger!

- Before installing or overhauling the System 300V, the power supplies must be disconnected from voltage (pull the plug or remove the fuse)!
- Installation and modifications only by properly trained personnel!

Cabling

Overview

The Co Power Supply is exclusively delivered with CageClamp contacts. Here the DC 24V power supply may be connected.



Danger!

- Before installation or overhauling, the power supplies must be disconnected from voltage (pull the plug or remove the fuse)!
- Installation and modifications only by properly trained personnel!

CageClamp technology (gray)

For the cabling gray connectors with CageClamp technology are used.

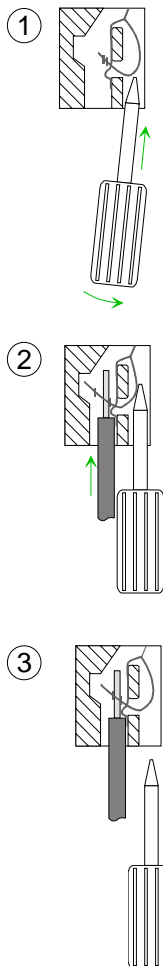

You may connect wires with a cross-section of 0.08mm^2 to 2.5mm^2 . You can use flexible wires without end case as well as stiff wires.

You fix the conductors to the CageClamps like this:

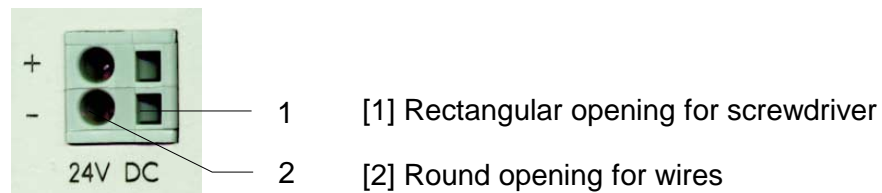

The picture on the left side shows the cabling step by step from top view.

- To conduct a wire you plug a fitting screwdriver obliquely into the rectangular opening like shown in the picture.
- To open the contact spring you have to push the screwdriver in the opposite direction and hold it.
- Insert the insulation striped wire into the round opening. You may use wires with a cross-section from 0.08mm^2 to 2.5mm^2 .
- By removing the screwdriver the wire is connected safely with the plug connector via a spring.

Installation guidelines

General

The installation guidelines contain information about the interference free deployment of System 300 systems. There is the description of the ways, interference may occur in your control, how you can make sure the electromagnetic digestibility (EMC), and how you manage the isolation.

What means EMC?

Electromagnetic digestibility (EMC) means the ability of an electrical device, to function error free in an electromagnetic environment without being interferenced res. without interfering the environment.

All System 300 components are developed for the deployment in hard industrial environments and fulfill high demands on the EMC. Nevertheless you should project an EMC planning before installing the components and take conceivable interference causes into account.

Electromagnetic interferences may interfere your control via different ways:

- Electromagnetic fields (RF coupling)
- Magnetic fields with power frequency
- I/O signal conductors
- Bus system
- Current supply
- Protected earth conductor

Depending on the spreading medium (lead bound or lead free) and the distance to the interference cause, interferences to your control occur by means of different coupling mechanisms.

One differs:

- galvanic coupling
- capacitive coupling
- inductive coupling
- radiant coupling

Basic rules for EMC

In the most times it is enough to take care of some elementary rules to guarantee the EMC. Please regard the following basic rules when installing your PLC.

- Take care of a correct area-wide grounding of the inactive metal parts when installing your components.
 - Install a central connection between the ground and the protected earth conductor system.
 - Connect all inactive metal extensive and impedance-low.
 - Please try not to use aluminum parts. Aluminum is easily oxidizing and is therefore less suitable for grounding.
- When cabling, take care of the correct line routing.
 - Organize your cabling in line groups (high voltage, current supply, signal and data lines).
 - Always lay your high voltage lines and signal res. data lines in separate channels or bundles.
 - Route the signal and data lines as near as possible beside ground areas (e.g. suspension bars, metal rails, tin cabinet).
- Proof the correct fixing of the lead isolation.
 - Data lines must be laid isolated (for details see below).
 - Analog lines must be laid isolated. When transmitting signals with small amplitudes the one sided laying of the isolation may be favorable.
 - Lay the line isolation extensively on an isolation/protected earth conductor rail directly after the cabinet entry and fix the isolation with cable clamps.
 - Make sure that the isolation/protected earth conductor rail is connected impedance-low with the cabinet.
 - Use metallic or metalized plug cases for isolated data lines.
- In special use cases you should appoint special EMC actions.
 - Wire all inductivities with erase links, which are not addressed by the System SLIO modules.
 - For lightening cabinets you should avoid luminescent lamps.
- Create a homogeneous reference potential and ground all electrical operating supplies when possible.
 - Please take care for the targeted employment of the grounding actions. The grounding of the PLC is a protection and functionality activity.
 - Connect installation parts and cabinets with the System SLIO in star topology with the isolation/protected earth conductor system. So you avoid ground loops.
 - If potential differences between installation parts and cabinets occur, lay sufficiently dimensioned potential compensation lines.

Isolation of conductors

Electrical, magnetically and electromagnetic interference fields are weakened by means of an isolation, one talks of absorption.

Via the isolation rail, that is connected conductive with the rack, interference currents are shunt via cable isolation to the ground. Hereby you have to make sure, that the connection to the protected earth conductor is impedance-low, because otherwise the interference currents may appear as interference cause.

When isolating cables you have to regard the following:

- If possible, use only cables with isolation tangle.
- The hiding power of the isolation should be higher than 80%.
- Normally you should always lay the isolation of cables on both sides. Only by means of the both-sided connection of the isolation you achieve high quality interference suppression in the higher frequency area.
Only as exception you may also lay the isolation one-sided. Then you only achieve the absorption of the lower frequencies. A one-sided isolation connection may be convenient, if:
 - the conduction of a potential compensating line is not possible
 - analog signals (some mV res. μA) are transferred
 - foil isolations (static isolations) are used.
- With data lines always use metallic or metalized plugs for serial couplings. Fix the isolation of the data line at the plug rack. Do not lay the isolation on the PIN 1 of the plug bar!
- At stationary operation it is convenient to strip the insulated cable interruption free and lay it on the isolation/protected earth conductor line.
- To fix the isolation tangles use cable clamps out of metal. The clamps must clasp the isolation extensively and have well contact.
- Lay the isolation on an isolation rail directly after the entry of the cable in the cabinet. Lead the isolation further on to the System 300V module and **don't** lay it on there again!

**Please regard at installation!**

At potential differences between the grounding points, there may be a compensation current via the isolation connected at both sides.

Remedy: Potential compensation line

General data

Conformity and approval		
Conformity		
CE	2006/95/EC	Low-voltage directive
	2004/108/EC	EMC directive
Approval		
UL	UL 508	Approval for USA and Canada
others		
RoHS	2011/65/EU	Product is lead-free; Restriction of the use of certain hazardous substances in electrical and electronic equipment

Protection of persons and device protection		
Type of protection	-	IP20
Electrical isolation		
to the field bus	-	electrically isolated
to the process level	-	electrically isolated
Insulation resistance	EN 61131-2	-
Insulation voltage to reference earth		
Inputs / outputs	-	AC / DC 50V, test voltage AC 500V
Protective measures	-	against short circuit

Environmental conditions to EN 61131-2		
Climatic		
Storage / transport	EN 60068-2-14	-25...+70°C
Operation		
Horizontal installation	EN 61131-2	0...+60°C
Vertical installation	EN 61131-2	0...+60°C
Air humidity	EN 60068-2-30	RH1 (without condensation, rel. humidity 10...95%)
Pollution	EN 61131-2	Degree of pollution 2
Mechanical		
Oscillation	EN 60068-2-6	1g, 9Hz ... 150Hz
Shock	EN 60068-2-27	15g, 11ms

Mounting conditions		
Mounting place	-	In the control cabinet
Mounting position	-	Horizontal and vertical

EMC	Standard	Comment
Emitted interference	EN 61000-6-4	Class A (Industrial area)
Noise immunity zone B	EN 61000-6-2	Industrial area
	EN 61000-4-2	ESD 8kV at air discharge (degree of severity 3), 4kV at contact discharge (degree of severity 2)
	EN 61000-4-3	HF irradiation (casing) 80MHz ... 1000MHz, 10V/m, 80% AM (1kHz) 1.4GHz ... 2.0GHz, 3V/m, 80% AM (1kHz) 2GHz ... 2.7GHz, 1V/m, 80% AM (1kHz)
	EN 61000-4-6	HF conducted 150kHz ... 80MHz, 10V, 80% AM (1kHz)
	EN 61000-4-4	Burst, degree of severity 3
	EN 61000-4-5	Surge, installation class 3 *)

*) Due to the high-energetic single pulses with Surge an appropriate external protective circuit with lightning protection elements like conductors for lightning and overvoltage is necessary.

Chapter 2 Hardware description and deployment

Overview Here the hardware structure and the deployment of the Co Power Supply together with the CPU 317S is described.
The technical data are at the end of the chapter.

Content	Topic	Page
	Chapter 2 Hardware description and deployment	2-1
	Safety Information for Users.....	2-2
	Properties.....	2-3
	Structure	2-4
	Technical data.....	2-5

Safety Information for Users

Handling of electrostatic sensitive modules

VIPA modules make use of highly integrated components in MOS-Technology. These components are extremely sensitive to over-voltages that can occur during electrostatic discharges.

The following symbol is attached to modules that can be destroyed by electrostatic discharges.



The symbol is located on the module, the module rack or on packing material and it indicates the presence of electrostatic sensitive equipment.

It is possible that electrostatic sensitive equipment is destroyed by energies and voltages that are far less than the human threshold of perception. These voltages can occur where persons do not discharge themselves before handling electrostatic sensitive modules and they can damage components thereby, causing the module to become inoperable or unusable. Modules, damaged in this way, are normally not immediately recognized. The according error may occur only after a while of operation.

Modules that have been damaged by electrostatic discharges can fail after a temperature change, mechanical shock or changes in the electrical load.

Only the consequent implementation of protection devices and meticulous attention to the applicable rules and regulations for handling the respective equipment can prevent failures of electrostatic sensitive modules.

Shipping of modules

Modules must be shipped in the original packing material.

Measurements and alterations on electrostatic sensitive modules

When you are conducting measurements on electrostatic sensitive modules you should take the following precautions:

- Floating instruments must be discharged before use.
- Instruments must be grounded.

Modifying electrostatic sensitive modules you should only use soldering irons with grounded tips.



Attention!

Personnel and instruments should be grounded when working on electrostatic sensitive modules.

Properties

Co Power Supply exclusive for CPU 317S

The SPEED7 CPU 317S has an integrated power supply, which is to be powered by DC 24V. The CPU and the connected modules at the standard and SPEED-Bus are powered by this power supply.

The total value of the current for the backplane bus may be increased with 5.5A by means of the Co Power Supply PS 307S_Co. The Co Power Supply is to be plugged directly at the SPEED-Bus left beside the CPU labeled with "Slot1 DCDC".

The Co Power Supply may only be operated together with the CPU 317S. As soon as the CPU 317S is power supplied, the Co Power Supply starts automatically.

PS 307S_Co 307-1BF70

- Operates exclusive together with the CPU 317S
- Output current 5.5A - extends the maximum total value at the backplane bus (Standard bus + SPEED-Bus)
- Automatic start-up with the power supply of the CPU 317S
- Defined power-down at failure of one of the power supplies
- Protection against short circuits and overloads
- Protection against overheat
- Efficiency typ. 90% at I_{Nom}

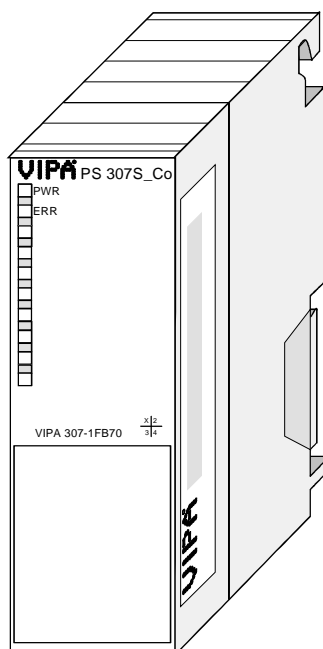

Order data

Order number	Description
VIPA 307-1BF70	Co Power Supply DC 24V

Structure

PS 307S_Co
307-1FB70

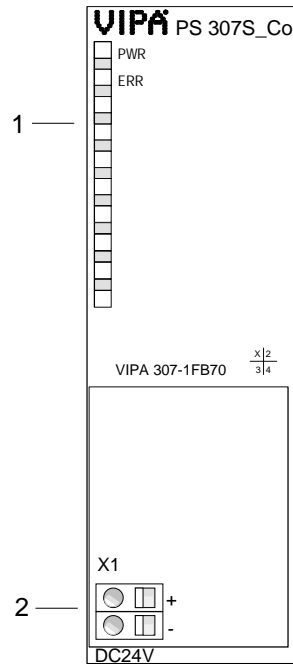

[1] LEDs status display

The following component is beneath a flap:

[2] Connector for DC 24V Power supply

DC 24V input

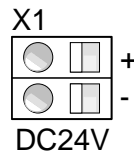

The Co Power Supply is to be provided with DC 24V by means of this connector. The connector is to be found beneath the front flap.

LEDs

The Co Power Supply has got one row of LEDs at the front side. The following table shows you the usage and the according colors.

Label	Color	Description
PWR	green	activated power supply by front side
SF	red	Error / Co Power Supply inactive On: If missing power supply of the CPU 317S, if wrong slot respectively if not mounted at SPEED-Bus.

Operation

As soon as the DC 24V input voltage is present at CPU 317S and Co Power Supply, the output voltage to the backplane bus is issued.

Here the output current at the backplane bus (standard bus + SPEED-Bus) is increased by 5.5A.

If the input voltage is missing at one power supply the other power supply remains inactive. If one of the power supplies is missing during operation a power-down is generated and the system is defined powered down. Here both power supplies are powered-off. After one second there is a restart executed.



Attention!

The Co Power Supply may only be (de-)connected at off-circuit conditions.

Technical data

Co Power Supply PS 307S_Co

Order no.	307-1FB70
Type	PS 307S - SPEED-Bus
SPEED-Bus	-
Technical data power supply	
Input voltage (rated value)	DC 24 V
Input voltage (permitted range)	DC 20.4...28.8 V
Mains frequency (rated value)	-
Mains frequency (permitted range)	-
Input current (at 120 V)	-
Input current (at 230 V)	-
Inrush current (at 25 °C)	5 A
I ² t	0.5 A ² s
Power consumption typ.	36 W
Output voltage (rated value)	5.2 V
Output current (rated value)	5.5 A
Power supply parallel switchable	-
Protect type	short circuit (electr.), overload, over temperature (IP20)
Ripple of output voltage (max.), BW=20 MHz	150 mV
Efficiency typ.	90 %
Power loss typ.	6 W
Status information, alarms, diagnostics	
Status display	yes
Interrupts	no
Process alarm	no
Diagnostic interrupt	no
Diagnostic functions	no
Diagnostics information read-out	none
Supply voltage display	green LED
Group error display	red LED
Channel error display	none
Housing	
Material	PPE / PA 6.6
Mounting	DIN rail SPEED-Bus
Mechanical data	
Dimensions (WxHxD)	40 x 125 x 120 mm
Weight	210 g
Environmental conditions	
Operating temperature	0 °C to 60 °C
Storage temperature	-25 °C to 70 °C
Certifications	
UL508 certification	-

