

VIPA System 200V

IM | Manual

HB97E_IM | RE_253-1IB00 | Rev. 12/44

November 2012



Copyright © VIPA GmbH. All Rights Reserved.

This document contains proprietary information of VIPA and is not to be disclosed or used except in accordance with applicable agreements.

This material is protected by the copyright laws. It may not be reproduced, distributed, or altered in any fashion by any entity (either internal or external to VIPA), except in accordance with applicable agreements, contracts or licensing, without the express written consent of VIPA and the business management owner of the material.

For permission to reproduce or distribute, please contact:
VIPA, Gesellschaft für Visualisierung und Prozessautomatisierung mbH
Ohmstraße 4, D-91074 Herzogenaurach, Germany
Tel.: +49 (91 32) 744 -0
Fax.: +49 9132 744 1864
EMail: info@vipa.de
<http://www.vipa.com>

Note

Every effort has been made to ensure that the information contained in this document was complete and accurate at the time of publishing. Nevertheless, the authors retain the right to modify the information. This customer document describes all the hardware units and functions known at the present time. Descriptions may be included for units which are not present at the customer site. The exact scope of delivery is described in the respective purchase contract.

CE Conformity Declaration

Hereby, VIPA GmbH declares that the products and systems are in compliance with the essential requirements and other relevant provisions.

Conformity is indicated by the CE marking affixed to the product.

Conformity Information

For more information regarding CE marking and Declaration of Conformity (DoC), please contact your local VIPA customer service organization.

Trademarks

VIPA, SLIO, System 100V, System 200V, System 300V, System 300S, System 400V, System 500S and Commander Compact are registered trademarks of VIPA Gesellschaft für Visualisierung und Prozessautomatisierung mbH.

SPEED7 is a registered trademark of profichip GmbH.

SIMATIC, STEP, SINEC, TIA Portal, S7-300 and S7-400 are registered trademarks of Siemens AG.

Microsoft und Windows are registered trademarks of Microsoft Inc., USA.

Portable Document Format (PDF) and Postscript are registered trademarks of Adobe Systems, Inc.

All other trademarks, logos and service or product marks specified herein are owned by their respective companies.

Information product support

Contact your local VIPA Customer Service Organization representative if you wish to report errors or questions regarding the contents of this document. If you are unable to locate a customer service center, contact VIPA as follows:

VIPA GmbH, Ohmstraße 4, 91074 Herzogenaurach, Germany

Telefax: +49 9132 744 1204
EMail: documentation@vipa.de

Technical support

Contact your local VIPA Customer Service Organization representative if you encounter problems with the product or have questions regarding the product. If you are unable to locate a customer service center, contact VIPA as follows:

VIPA GmbH, Ohmstraße 4, 91074 Herzogenaurach, Germany

Telephone: +49 9132 744 1150 (Hotline)
EMail: support@vipa.de

Contents

About this manual	1
Safety information	2
Chapter 1 Basics and Assembly	1-1
Safety Information for Users.....	1-2
System conception	1-3
Dimensions	1-5
Installation	1-7
Demounting and module exchange	1-11
Wiring.....	1-12
Installation guidelines	1-14
General data	1-17
Chapter 2 Hardware description	2-1
Properties.....	2-2
IM 253IBS - Interbus coupler - Structure	2-3
Connection to Interbus	2-6
Technical Data	2-7
Chapter 3 Deployment IM 253IBS.....	3-1
Basics	3-2
Deployment with Interbus	3-6
Commissioning.....	3-10

About this manual

This manual describes the System 200V Interbus slave module IM 253IBS from VIPA. Here you may find every information for commissioning and operation.

Overview

Chapter 1: Basics and Assembly

The focus of this chapter is on the introduction of the VIPA System 200V. Here you will find the information required to assemble and wire a controller system consisting of System 200V components.

Besides the dimensions the general technical data of System 200V will be found.

Chapter 2: Hardware description

Here the hardware components of the IM 253-1IB00 are described.

The technical data are at the end of the chapter.

Chapter 3: Deployment IM 253IBS

This chapter contains all the information that you require to connect your System 200V periphery to Interbus.

After the Interbus basics followed by the description of the application in the Interbus and commissioning the IM 253IBS.

Objective and contents

This manual describes the System 200V Interbus slave module IM 253IBS from VIPA. It contains a description of the construction, project implementation and usage.

This manual is part of the documentation package with order number HB97E_IM and relevant for:

Product	Order number	as of state: HW
IM 253IBS	VIPA 253-1IB00	01

Target audience

The manual is targeted at users who have a background in automation technology.

Structure of the manual

The manual consists of chapters. Every chapter provides a self-contained description of a specific topic.

Guide to the document

The following guides are available in the manual:

- an overall table of contents at the beginning of the manual
- an overview of the topics for every chapter

Availability

The manual is available in:

- printed form, on paper
- in electronic form as PDF-file (Adobe Acrobat Reader)

Icons Headings

Important passages in the text are highlighted by following icons and headings:

**Danger!**

Immediate or likely danger.
Personal injury is possible.

**Attention!**

Damages to property is likely if these warnings are not heeded.

**Note!**

Supplementary information and useful tips.

Safety information

Applications conforming with specifications

The IM 253IBS is constructed and produced for:

- all VIPA System 200V components
- communication and process control
- general control and automation applications
- industrial applications
- operation within the environmental conditions specified in the technical data
- installation into a cubicle



Danger!

This device is not certified for applications in

- in explosive environments (EX-zone)

Documentation

The manual must be available to all personnel in the

- project design department
- installation department
- commissioning
- operation



The following conditions must be met before using or commissioning the components described in this manual:

- Hardware modifications to the process control system should only be carried out when the system has been disconnected from power!
- Installation and hardware modification only by properly trained personnel.
- The national rules and regulations of the respective country must be satisfied (installation, safety, EMC ...)

Disposal

National rules and regulations apply to the disposal of the unit!

Chapter 1 Basics and Assembly

Overview

The focus of this chapter is on the introduction of the VIPA System 200V. Here you will find the information required to assemble and wire a controller system consisting of System 200V components.

Besides the dimensions the general technical data of System 200V will be found.

Contents

Topic	Page
Chapter 1 Basics and Assembly	1-1
Safety Information for Users	1-2
System conception	1-3
Dimensions	1-5
Installation	1-7
Demounting and module exchange	1-11
Wiring	1-12
Installation guidelines	1-14
General data	1-17

Safety Information for Users

Handling of electrostatic sensitive modules

VIPA modules make use of highly integrated components in MOS-Technology. These components are extremely sensitive to over-voltages that can occur during electrostatic discharges.

The following symbol is attached to modules that can be destroyed by electrostatic discharges.



The Symbol is located on the module, the module rack or on packing material and it indicates the presence of electrostatic sensitive equipment.

It is possible that electrostatic sensitive equipment is destroyed by energies and voltages that are far less than the human threshold of perception. These voltages can occur where persons do not discharge themselves before handling electrostatic sensitive modules and they can damage components thereby, causing the module to become inoperable or unusable.

Modules that have been damaged by electrostatic discharges can fail after a temperature change, mechanical shock or changes in the electrical load.

Only the consequent implementation of protection devices and meticulous attention to the applicable rules and regulations for handling the respective equipment can prevent failures of electrostatic sensitive modules.

Shipping of electrostatic sensitive modules

Modules must be shipped in the original packing material.

Measurements and alterations on electrostatic sensitive modules

When you are conducting measurements on electrostatic sensitive modules you should take the following precautions:

- Floating instruments must be discharged before use.
- Instruments must be grounded.

Modifying electrostatic sensitive modules you should only use soldering irons with grounded tips.



Attention!

Personnel and instruments should be grounded when working on electrostatic sensitive modules.

System conception

Overview

The System 200V is a modular automation system for assembly on a 35mm profile rail. By means of the peripheral modules with 4, 8 and 16 channels this system may properly be adapted matching to your automation tasks.

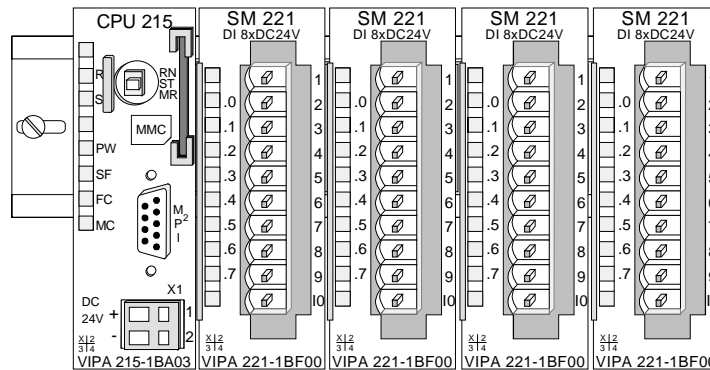

Components

The System 200V consists of the following components:

- Head modules like CPU and bus coupler
- Periphery modules like I/O, function und communication modules
- Power supplies
- Extension modules

Head modules

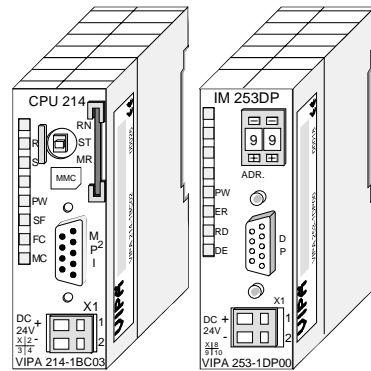

With a head module CPU respectively bus interface and DC 24V power supply are integrated to one casing.

Via the integrated power supply the CPU respectively bus interface is power supplied as well as the electronic of the connected periphery modules.

Periphery modules

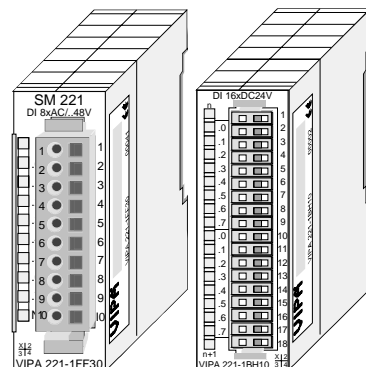

The modules are direct installed on a 35mm profile rail and connected to the head module by a bus connector, which was mounted on the profile rail before.

Most of the periphery modules are equipped with a 10pin respectively 18pin connector. This connector provides the electrical interface for the signaling and supplies lines of the modules.

Power supplies

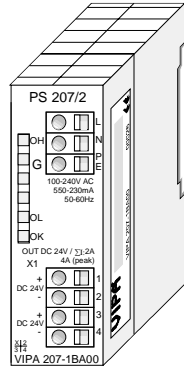

With the System 200V the DC 24V power supply can take place either externally or via a particularly for this developed power supply.

The power supply may be mounted on the profile rail together with the System 200V modules. It has no connector to the backplane bus.

Expansion modules

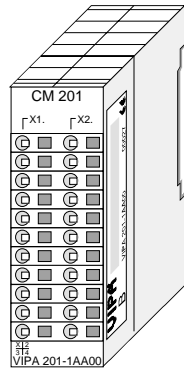

The expansion modules are complementary modules providing 2- or 3wire connection facilities.

The modules are not connected to the backplane bus.

Structure/ dimensions

- Profile rail 35mm
- Dimensions of the basic enclosure:
 - 1tier width: (HxWxD) in mm: 76x25.4x74 in inches: 3x1x3
 - 2tier width: (HxWxD) in mm: 76x50.8x74 in inches: 3x2x3

Installation

Please note that you can only install head modules, like the CPU, the PC and couplers at slot 1 or 1 and 2 (for double width modules).

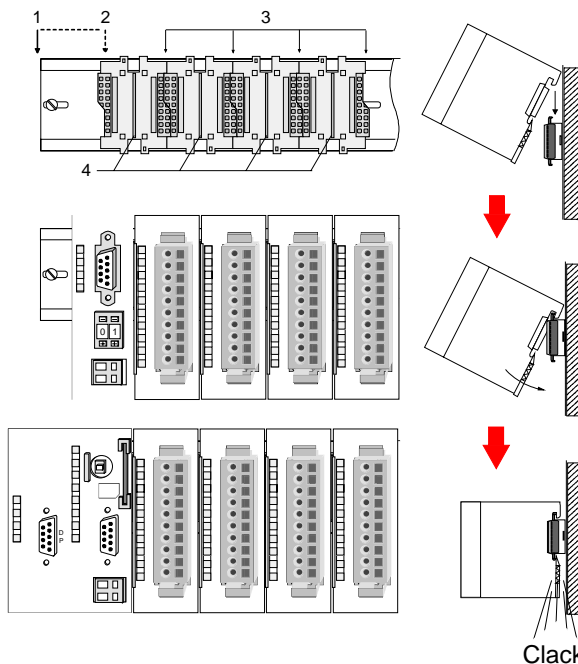

[1]	Head module (double width)
[2]	Head module (single width)
[3]	Periphery module
[4]	Guide rails

Note

Information about the max. number of pluggable modules and the max. current at the backplane bus can be found in the "Technical Data" of the according head module.

Please install modules with a high current consumption directly beside the head module.

Dimensions

Dimensions 1tier width (HxWxD) in mm: 76 x 25.4 x 74
Basic enclosure 2tier width (HxWxD) in mm: 76 x 50.8 x 74

Installation dimensions

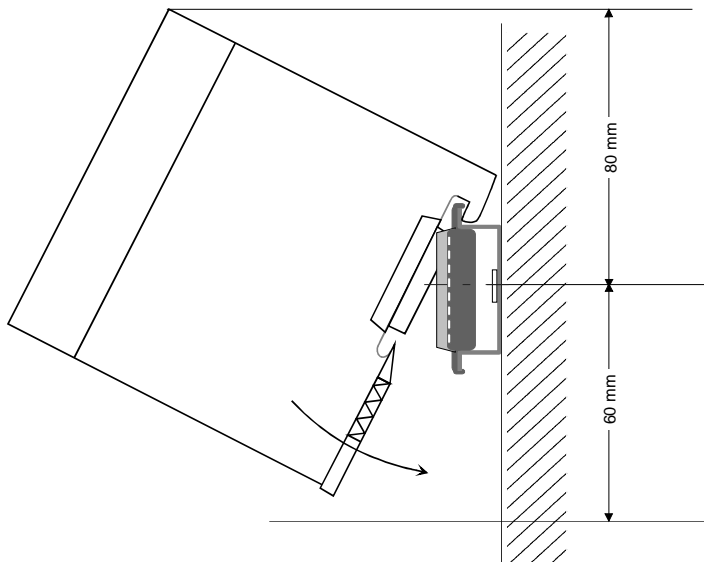

Installed and wired dimensions

In- / Output modules

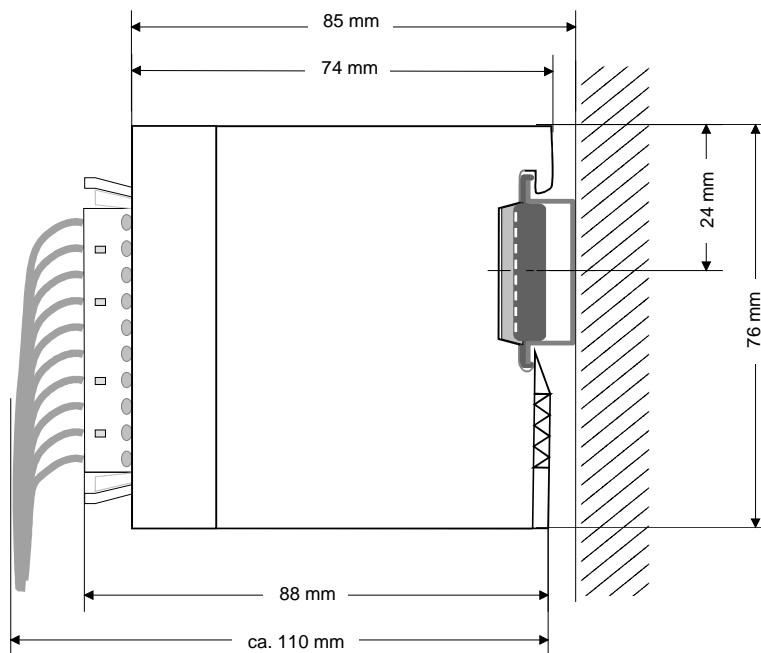

Function modules/
Extension modules

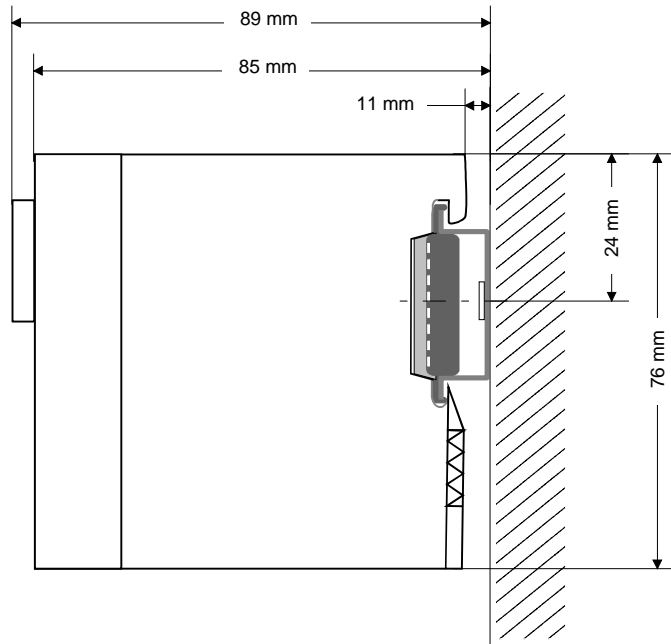

CPUs (here with
EasyConn from
VIPA)

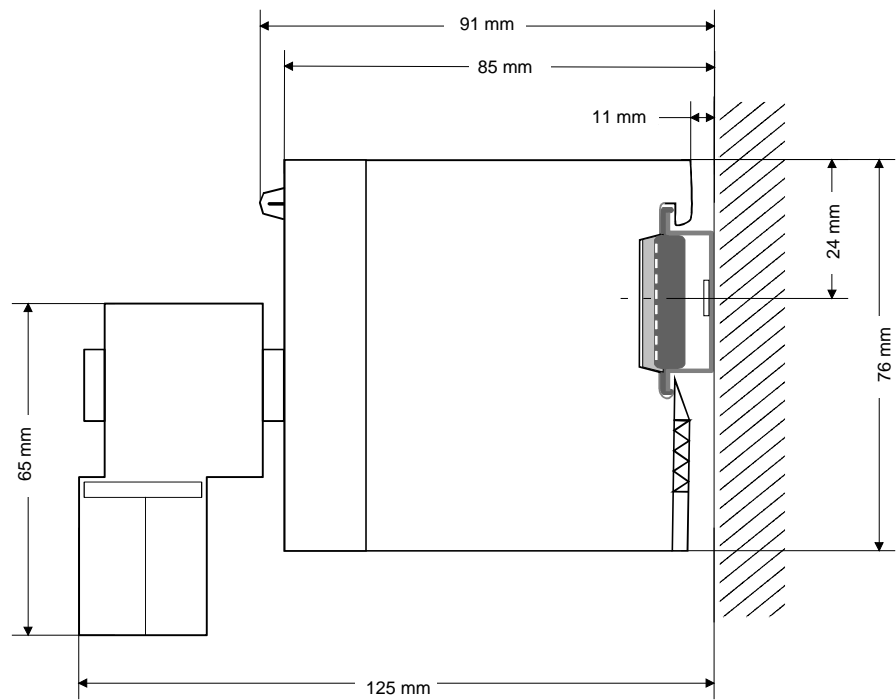

Installation

General

The modules are each installed on a 35mm profile rail and connected via a bus connector. Before installing the module the bus connector is to be placed on the profile rail before.

Profile rail

For installation the following 35mm profile rails may be used:

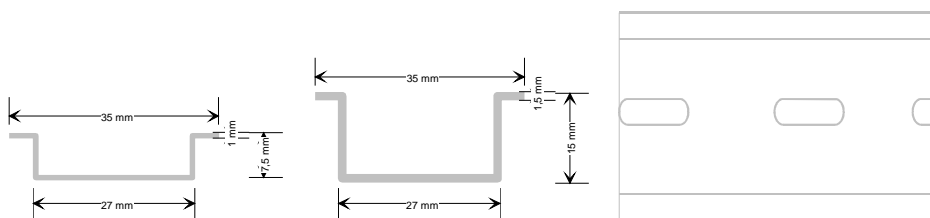

Order number	Label	Description
290-1AF00	35mm profile rail	Length 2000mm, height 15mm
290-1AF30	35mm profile rail	Length 530mm, height 15mm

Bus connector

System 200V modules communicate via a backplane bus connector. The backplane bus connector is isolated and available from VIPA in of 1-, 2-, 4- or 8tier width.

The following figure shows a 1tier connector and a 4tier connector bus:

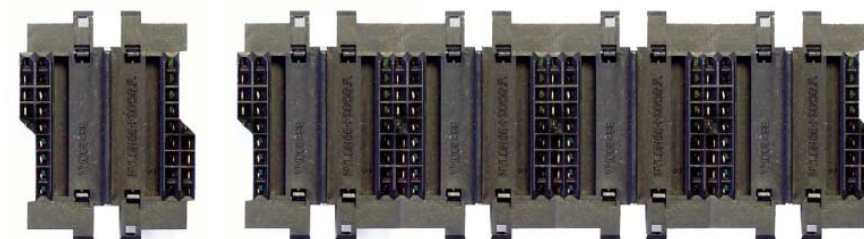

The bus connector is to be placed on the profile rail until it clips in its place and the bus connections look out from the profile rail.

Order number	Label	Description
290-0AA10	Bus connector	1tier
290-0AA20	Bus connector	2tier
290-0AA40	Bus connector	4tier
290-0AA80	Bus connector	8tier

Installation on a profile rail

The following figure shows the installation of a 4tier width bus connector in a profile rail and the slots for the modules.

The different slots are defined by guide rails.

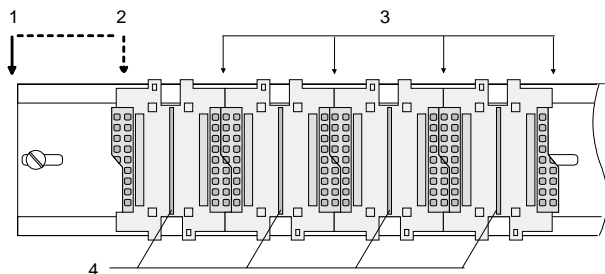

- [1] Head module (double width)
- [2] Head module (single width)
- [3] Peripheral module
- [4] Guide rails

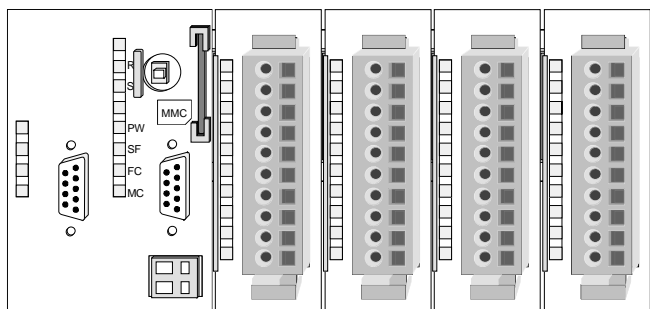
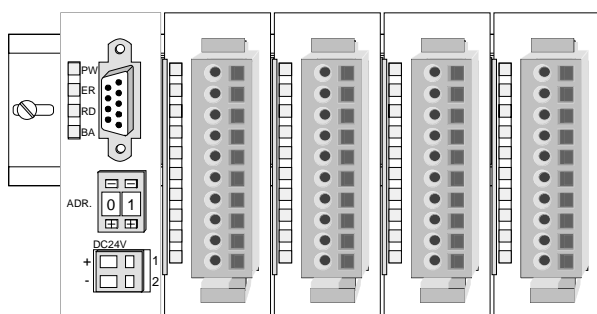

Assembly regarding the current consumption

- Use bus connectors as long as possible.
- Sort the modules with a high current consumption right beside the head module. In the service area of www.vipa.com a list of current consumption of every System 200V module can be found.

Assembly possibilities

horizontal assembly

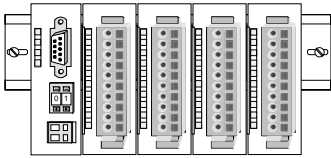

vertical assembly

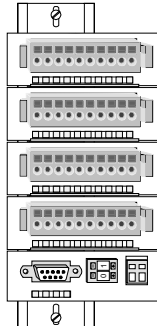

lying assembly

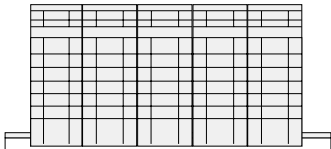

Please regard the allowed environmental temperatures:

- horizontal assembly: from 0 to 60°C
- vertical assembly: from 0 to 40°C
- lying assembly: from 0 to 40°C

The horizontal assembly always starts at the left side with a head module, then you install the peripheral modules beside to the right.

You may install up to 32 peripheral modules.

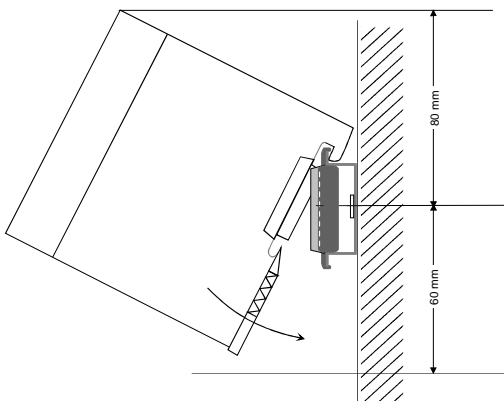

Please follow these rules during the assembly!

- Turn off the power supply before you install or remove any modules!
- Make sure that a clearance of at least 60mm exists above and 80mm below the middle of the profile rail.

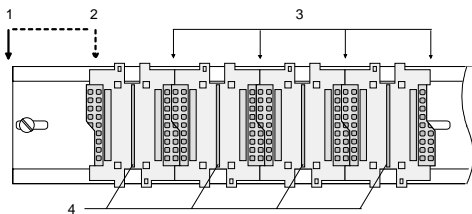

- Every row must be completed from left to right and it has to start with a head module.

- [1] Head module (double width)
- [2] Head module (single width)
- [3] Peripheral modules
- [4] Guide rails

- Modules are to be installed side by side. Gaps are not permitted between the modules since this would interrupt the backplane bus.
- A module is only installed properly and connected electrically when it has clicked into place with an audible click.
- Slots after the last module may remain unoccupied.



Note!

Information about the max. number of pluggable modules and the max. current at the backplane bus can be found in the "Technical Data" of the according head module.

Please install modules with a high current consumption directly beside the head module.

Assembly procedure

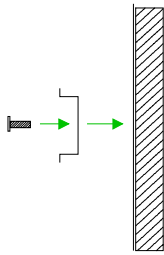

- Install the profile rail. Make sure that a clearance of at least 60mm exists above and 80mm below the middle of the profile rail.

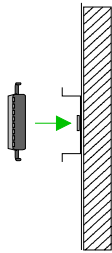

- Press the bus connector into the profile rail until it clips securely into place and the bus-connectors look out from the profile rail. This provides the basis for the installation of your modules.

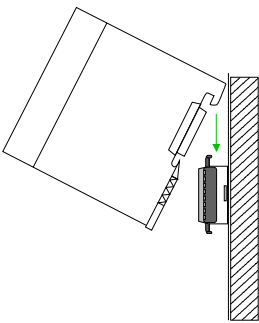

- Start at the outer left location with the installation of your head module and install the peripheral modules to the right of this.

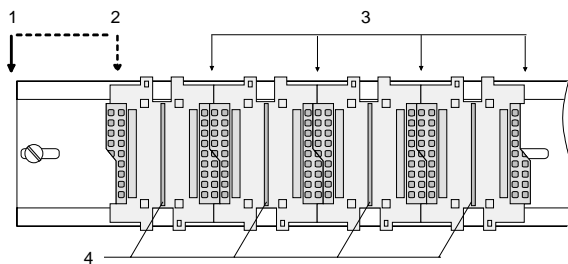

- [1] Head module (double width)
- [2] Head module (single width)
- [3] Peripheral module
- [4] Guide rails

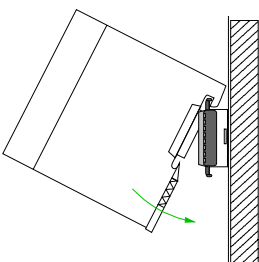

- Insert the module that you are installing into the profile rail at an angle of 45 degrees from the top and rotate the module into place until it clicks into the profile rail with an audible click. The proper connection to the backplane bus can only be guaranteed when the module has properly clicked into place.



Attention!

Power must be turned off before modules are installed or removed!

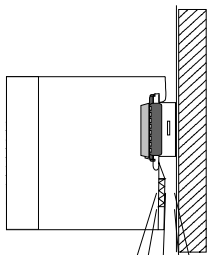

Clack

Demounting and module exchange

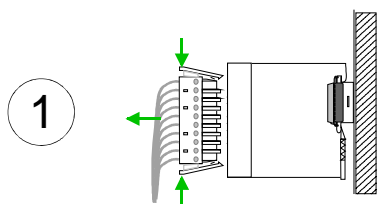

- Remove if exists the wiring to the module, by pressing both locking lever on the connector and pulling the connector.

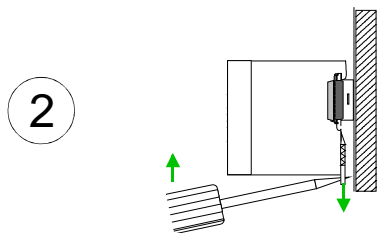

- The casing of the module has a spring loaded clip at the bottom by which the module can be removed.

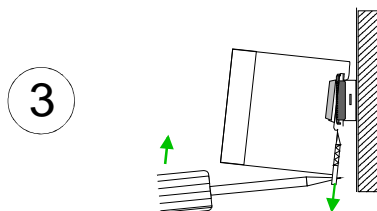

- The clip is unlocked by pressing the screwdriver in an upward direction.

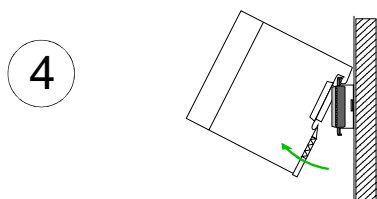

- Withdraw the module with a slight rotation to the top.

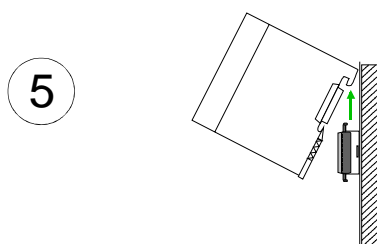

Attention!

Power must be turned off before modules are installed or removed!

Please regard that the backplane bus is interrupted at the point where the module was removed!

Wiring

Overview

Most peripheral modules are equipped with a 10pole or a 18pole connector. This connector provides the electrical interface for the signaling and supply lines of the modules.

The modules carry spring-clip connectors for interconnections and wiring.

The spring-clip connector technology simplifies the wiring requirements for signaling and power cables.

In contrast to screw terminal connections, spring-clip wiring is vibration proof. The assignment of the terminals is contained in the description of the respective modules.

You may connect conductors with a diameter from 0.08mm² up to 2.5mm² (max. 1.5mm² for 18pole connectors).

The following figure shows a module with a 10pole connector.

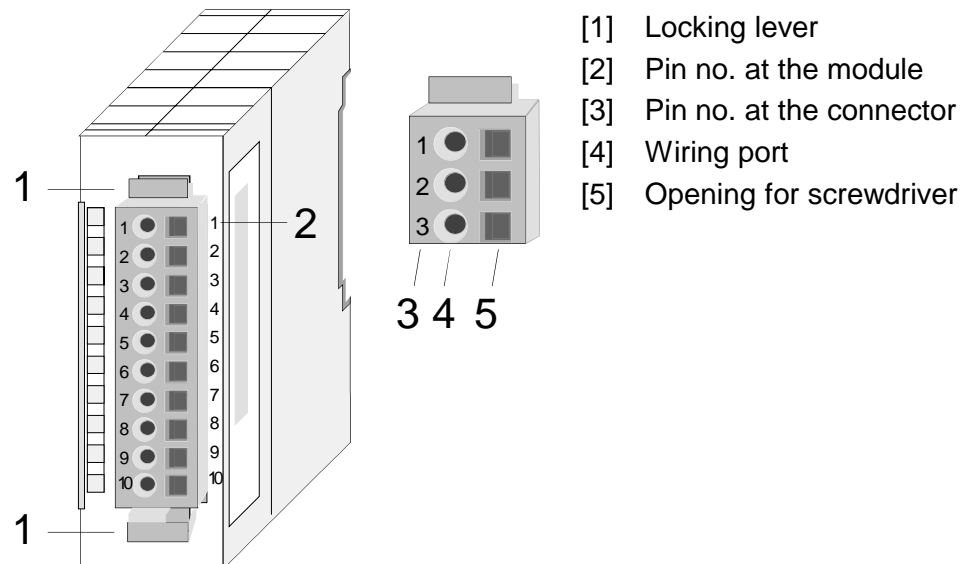

Note!

The spring-clip is destroyed if you push the screwdriver into the wire port! Make sure that you only insert the screwdriver into the square hole of the connector!

Wiring procedure

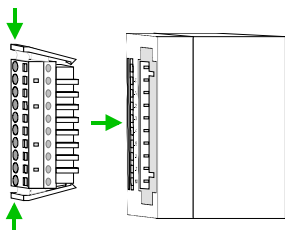

- Install the connector on the module until it locks with an audible click. For this purpose you press the two clips together as shown. The connector is now in a permanent position and can easily be wired.

The following section shows the wiring procedure from top view.

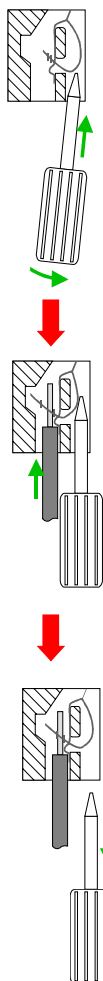

- Insert a screwdriver at an angle into the square opening as shown.
- Press and hold the screwdriver in the opposite direction to open the contact spring.
- Insert the stripped end of the wire into the round opening. You can use wires with a diameter of 0.08mm² to 2.5mm² (1.5mm² for 18pole connectors).
- By removing the screwdriver the wire is connected safely with the plug connector via a spring.



Note!

Wire the power supply connections first followed by the signal cables (inputs and outputs).

Installation guidelines

General The installation guidelines contain information about the interference free deployment of System 200V systems. There is the description of the ways, interference may occur in your control, how you can make sure the electromagnetic digestibility (EMC), and how you manage the isolation.

What means EMC? Electromagnetic digestibility (EMC) means the ability of an electrical device, to function error free in an electromagnetic environment without being interferenced res. without interfering the environment.
All System 200V components are developed for the deployment in hard industrial environments and fulfill high demands on the EMC. Nevertheless you should project an EMC planning before installing the components and take conceivable interference causes into account.

Possible interference causes Electromagnetic interferences may interfere your control via different ways:

- Fields
- I/O signal conductors
- Bus system
- Current supply
- Protected earth conductor

Depending on the spreading medium (lead bound or lead free) and the distance to the interference cause, interferences to your control occur by means of different coupling mechanisms.

One differs:

- galvanic coupling
- capacitive coupling
- inductive coupling
- radiant coupling

Basic rules for EMC

In the most times it is enough to take care of some elementary rules to guarantee the EMC. Please regard the following basic rules when installing your PLC.

- Take care of a correct area-wide grounding of the inactive metal parts when installing your components.
 - Install a central connection between the ground and the protected earth conductor system.
 - Connect all inactive metal extensive and impedance-low.
 - Please try not to use aluminum parts. Aluminum is easily oxidizing and is therefore less suitable for grounding.
- When cabling, take care of the correct line routing.
 - Organize your cabling in line groups (high voltage, current supply, signal and data lines).
 - Always lay your high voltage lines and signal res. data lines in separate channels or bundles.
 - Route the signal and data lines as near as possible beside ground areas (e.g. suspension bars, metal rails, tin cabinet).
- Proof the correct fixing of the lead isolation.
 - Data lines must be laid isolated.
 - Analog lines must be laid isolated. When transmitting signals with small amplitudes the one sided laying of the isolation may be favorable.
 - Lay the line isolation extensively on an isolation/protected earth conductor rail directly after the cabinet entry and fix the isolation with cable clamps.
 - Make sure that the isolation/protected earth conductor rail is connected impedance-low with the cabinet.
 - Use metallic or metalized plug cases for isolated data lines.
- In special use cases you should appoint special EMC actions.
 - Wire all inductivities with erase links.
 - Please consider luminescent lamps can influence signal lines.
- Create a homogeneous reference potential and ground all electrical operating supplies when possible.
 - Please take care for the targeted employment of the grounding actions. The grounding of the PLC is a protection and functionality activity.
 - Connect installation parts and cabinets with the System 200V in star topology with the isolation/protected earth conductor system. So you avoid ground loops.
 - If potential differences between installation parts and cabinets occur, lay sufficiently dimensioned potential compensation lines.

Isolation of conductors

Electrical, magnetically and electromagnetic interference fields are weakened by means of an isolation, one talks of absorption.

Via the isolation rail, that is connected conductive with the rack, interference currents are shunt via cable isolation to the ground. Hereby you have to make sure, that the connection to the protected earth conductor is impedance-low, because otherwise the interference currents may appear as interference cause.

When isolating cables you have to regard the following:

- If possible, use only cables with isolation tangle.
- The hiding power of the isolation should be higher than 80%.
- Normally you should always lay the isolation of cables on both sides. Only by means of the both-sided connection of the isolation you achieve high quality interference suppression in the higher frequency area. Only as exception you may also lay the isolation one-sided. Then you only achieve the absorption of the lower frequencies. A one-sided isolation connection may be convenient, if:
 - the conduction of a potential compensating line is not possible
 - analog signals (some mV res. μ A) are transferred
 - foil isolations (static isolations) are used.
- With data lines always use metallic or metalized plugs for serial couplings. Fix the isolation of the data line at the plug rack. Do not lay the isolation on the PIN 1 of the plug bar!
- At stationary operation it is convenient to strip the insulated cable interruption free and lay it on the isolation/protected earth conductor line.
- To fix the isolation tangles use cable clamps out of metal. The clamps must clasp the isolation extensively and have well contact.
- Lay the isolation on an isolation rail directly after the entry of the cable in the cabinet. Lead the isolation further on to the System 200V module and **don't** lay it on there again!

**Please regard at installation!**

At potential differences between the grounding points, there may be a compensation current via the isolation connected at both sides.

Remedy: Potential compensation line.

General data

Structure/ dimensions

- Profile rail 35mm
- Peripheral modules with recessed labelling
- Dimensions of the basic enclosure:
1tier width: (HxWxD) in mm: 76x25.4x74 in inches: 3x1x3
2tier width: (HxWxD) in mm: 76x50.8x74 in inches: 3x2x3

Reliability

- Wiring by means of spring pressure connections (CageClamps) at the front-facing connector, core cross-section 0.08 ... 2.5mm² or 1.5 mm² (18pole plug)
- Complete isolation of the wiring when modules are exchanged
- Every module is isolated from the backplane bus
- ESD/Burst acc. IEC 61000-4-2 / IEC 61000-4-4 (to level 3)
- Shock resistance acc. IEC 60068-2-6 / IEC 60068-2-27 (1G/12G)
- Class of protection IP20

Environmental conditions

- Operating temperature: 0 ... +60°C
- Storage temperature: -25 ... +70°C
- Relative humidity: 5 ... 95% without condensation
- Ventilation by means of a fan is not required

Chapter 2 Hardware description

Overview Here the hardware components of the IM 253-1IB00 are described.
The technical data are at the end of the chapter.

Contents	Topic	Page
	Chapter 2 Hardware description.....	2-1
	Properties.....	2-2
	Structure	2-3
	Connection to Interbus	2-6
	Technical Data	2-7

Properties

IM 253IBS 253-1IB00

You can use the VIPA Interbus slave to connect up to the following input and output modules of the System 200V to your Interbus.

- Max. digital In-/Output: 16
(process data width In-/Output: 20byte / 20byte)
- Max. analog In-/Output: 4
(process data width 10byte / 10byte)

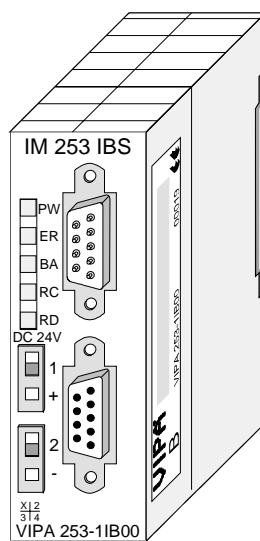

Order data

Type	Order number	Description
IM 253IBS	VIPA 253-1IB00	Interbus slave

Structure

Front view 253-1IB00

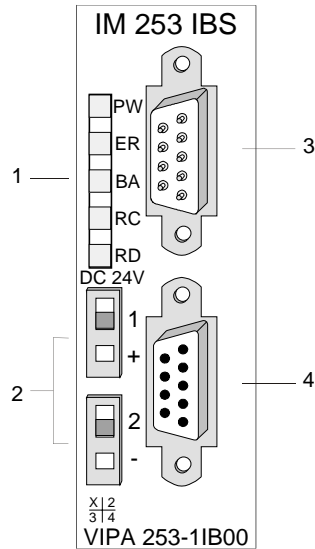

- [1] LED status indicators
- [2] Power supply connector for the external 24V supply
- [3] Interbus plug inbound interface
- [4] Interbus socket outbound interface

Interfaces

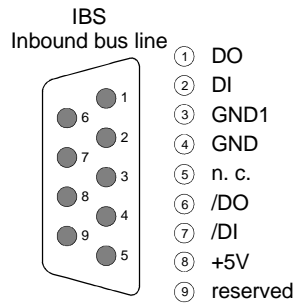

DC 24 V

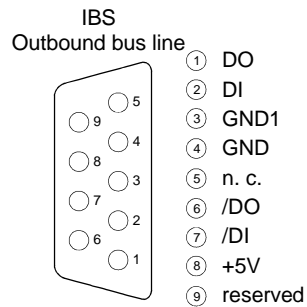

Power supply

The Interbus coupler has an internal power supply.
This power supply requires an external voltage of DC 24V.

DC 24 V

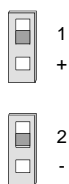

In addition to the internal circuitry of the bus coupler, the supply voltage is also used to power any devices connected to the backplane bus.
The "max. current drain at backplane bus" can be found in the Technical Data. The power supply is protected against reverse polarity.
Interbus and the backplane bus are isolated from each other.



Note!

Please pay attention to the polarity of the power supply!

Jacks and plugs

The interfaces for the inbound and the outbound bus lines are located on the front of the module. These consist of 9pin D-type connectors.
The following diagram shows the pin assignment for this interface:

Inbound bus line (9pin D-type plug)

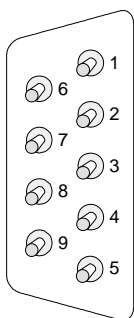

Pin	Assignment
1	DO
2	DI
3	GND1
4	GND ^{*)}
5	n. c.
6	/DO
7	/DI
8	+5V ^{*)} (90 mA)
9	reserved

^{*)} power for the fiber optic converter.
This voltage is not isolated!

Outbound bus line (9pin D-type socket)

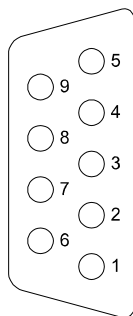

Pin	Assignment
1	DO
2	DI
3	GND
4	reserved
5	+ 5V (90 mA)
6	/DO
7	/DI
8	reserved
9	RBST

LEDs

The module has a number of LEDs are available for diagnostic purposes on the bus. The following table explains the purpose and the color of the different LEDs:

Label	Color	Description
PW	yellow	Power LED Indicates that the supply voltage is available.
ER	red	Error Application error.
BA	green	Bus active The BA LED (Bus active) indicates an active Interbus data transfer.
RC	green	Remote bus Check The RC LED (remote bus Check) indicates that the connection to the previous Interbus device is OK (on) or that it has been interrupted (off).
RD	red	Remote bus disabled The RD LED (remote bus Disabled) indicates that the outbound remote bus has been disabled.

Connection to Interbus

Interbus wiring requirements

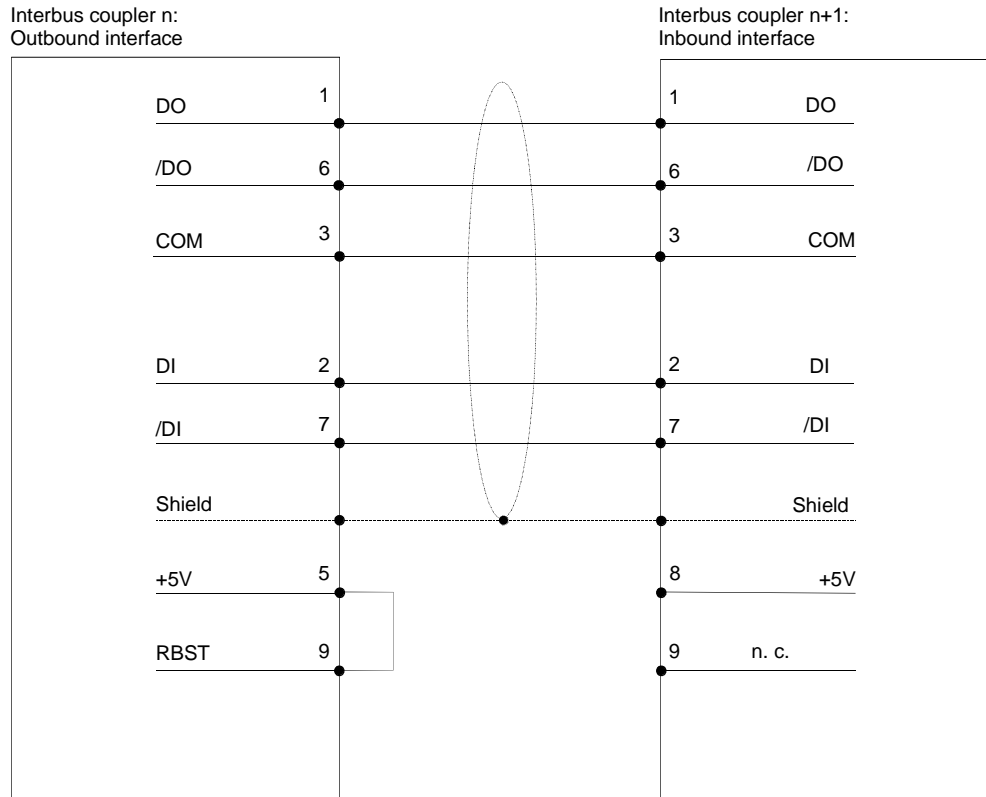

Isolation

Due to the fact that Interbus remote bus segments can be distributed over large areas, it is necessary that individual segments are isolated galvanically to prevent problems that could be caused by potential differences. However, according to the recommendations of the Interbus club, it is sufficient to provide galvanic isolation between inbound remote bus interfaces and the remainder of the circuitry. For this reason the outbound remote bus interface is at the same potential as the rest of the circuitry and the backplane bus.

Use metallic covers for plugs and apply the screen of the cable to the plug case.



Note!

Please ensure that the link between pins 5 and 9 is installed on the plug for "subsequent modules" as any subsequent slaves would not be detected if the link was not present!

Technical Data

Order number	253-1IB00
Type	IM 253IBS, INTERBUS slave
Technical data power supply	
Power supply (rated value)	DC 24 V
Power supply (permitted range)	DC 20.4...28.8 V
Reverse polarity protection	✓
Current consumption (no-load operation)	50 mA
Current consumption (rated value)	800 mA
Inrush current	60 A
I^2t	0.6 A ² s
Max. current drain at backplane bus	3.5 A
Max. current drain load supply	-
Power loss	2 W
Status information, alarms, diagnostics	
Status display	yes
Interrupts	no
Process alarm	no
Diagnostic interrupt	no
Diagnostic functions	no
Diagnostics information read-out	none
Supply voltage display	green LED
Service Indicator	-
Group error display	red LED
Channel error display	none
Hardware configuration	
Racks, max.	1
Modules per rack, max.	16
Number of digital modules, max.	16
Number of analog modules, max.	4
Communication	
Fieldbus	INTERBUS-S to DIN 19258
Type of interface	RS422
Connector	Sub-D, 9-pin, male (in) and female (out)
Topology	Ring with integrated return line
Electrically isolated	✓
Number of participants, max.	256
Node addresses	-
Transmission speed, min.	-
Transmission speed, max.	500 kbit/s
Address range inputs, max.	20 Byte
Address range outputs, max.	20 Byte
Number of TxPDOs, max.	-
Number of RxPDOs, max.	-
Housing	
Material	PPE / PA 6.6
Mounting	Profile rail 35 mm

Order number	253-1IB00
Mechanical data	
Dimensions (WxHxD)	25.4 x 76 x 78 mm
Weight	100 g
Environmental conditions	
Operating temperature	0 °C to 60 °C
Storage temperature	-25 °C to 70 °C
Certifications	
UL508 certification	yes

Chapter 3 Deployment IM 253IBS

Overview

This chapter contains all the information that you require to connect your System 200V periphery to Interbus.

After the Interbus basics followed by the description of the application in the Interbus and commissioning the IM 253IBS.

Contents

Topic	Page
Chapter 3 Deployment IM 253IBS.....	3-1
Basics	3-2
Deployment with Interbus	3-6
Commissioning.....	3-10

Basics

- General** Interbus is a pure master/slave system that has very few protocol overheads. For this reason it is well suited for applications on the sensor/actuator level. Interbus was developed by PHOENIX CONTACT, Digital Equipment and the Technical University of Lemgo during the 80s. The first system components became available in 1988. To this day the communication protocol has remained virtually unchanged. It is therefore means that it is entirely possible to connect devices of the first generation to the most recent master interfaces (generation 4).
- Interbus for sensor and actuator level** The widespread use of Interbus for sensor/actuator level applications may be ascribed to the relatively simple interfacing requirements that are supported by protocol driver chips. These reduce the number of external components required for direct input or output interfacing to a minimum. Interbus devices are subject to the DIN standard 19258 that defines levels 1 and 2 of the protocol amongst others.
- Interbus as shift register** The Interbus system is designed as a ring-type network with a central master-slave access procedure. It has the structure of a distributed shift register. The different registers of the devices connected to the ring are a portion of this shift register. The master shifts the data through this shift register. The ring structure of the network permits simultaneous transmission and reception of data. Data may be sent in both directions on the ring, which uses a single cable.
- ID register** Every Interbus module has an ID register (identification register). This register contains information on the type of module, the number of input and output registers as well as status and error flags.
- Interbus master** The Interbus coupler can be used to control the peripheral modules of the System 200V via Interbus. In this case the bus coupler replaces the CPU. The Interbus master reads and writes data from/to inputs and outputs respectively. The master is the link to other systems. Every master can control a maximum of 4096 input/output points. These may be located on the local bus or they may be distributed amongst secondary structures connected by means of bus couplers.
- It is possible to connect remote ring systems to the main ring to provide a structured system. These remote ring systems are connected by means of bus terminal modules. You can also use these bus terminal modules for long distance communications.

Restrictions on the data capacity

The hardware overhead for Interbus devices increases in proportion with the width of the data. It is for this reason that the maximum data width was limited to 20Byte input data and 20Byte output data.

Secondary Interbus segments (peripheral busses) can be connected or disconnected by means of the respective bus coupler. For this reason the bus can remain operational even if a fault occurs on a peripheral bus connection. The faulty segment can be disconnected from the bus.

Operating modes

Interbus has two modes of operation:

- ID cycle
An ID cycle is issued when the Interbus system is being initialized and also upon request. During the ID cycle the bus master reads the ID register of every module connected to the bus to generate the process image.
- Data cycle
The actual transfer of data occurs during the data cycle. During the data cycle the input data from the registers of all devices is transferred to the master and the output data is transferred from the master to the devices. This is a full duplex data transfer.

Communication medium

Although Interbus appears to have a simple linear structure (a single line linking the master with every module), it has the structure of a ring that includes the outbound line and the return line in a single cable. The last device on the ring closes the loop. On most devices this is an automatic function that occurs when no further line segments are connected.

The physical level of Interbus is based upon the RS422 standard. The signals are connected by means of twisted pair lines. The outbound signal as well as the return signal of Interbus is re-routed via the same cable and every connected station. Communications between 2 devices require a 5core cable due to the ring-based structure and the common logic ground. At a data communications rate of 500kBaud two adjacent stations on the ring may be located at a distance of no more than 400m. The integral repeater function of every device on the bus allows a total distance of up to 13km. The maximum number of devices on the bus is limited to 512.

Process data transfer

Interbus is based upon a ring structure that operates as a cyclic shift register. Every Interbus module inserts a shift register into the ring. The number of I/O points supported by the module determines the length of this shift register. A ring-based shift register is formed due to the fact that all the devices are connected in series and that the output of the last shift register is returned to the bus master. The length and the structure of this shift register depend on the physical construction of the entire Interbus system.

Interbus operates by means of a master-slave access method where the master also provides the link to any high-level control system. The ring-structure includes all connected devices actively in a closed communication loop.

In comparison to client-server protocols where data is only exchanged when a client receives a properly addressed command, Interbus communications is cyclic in nature and data is exchanged at constant intervals. Every data cycle addresses all devices on the bus.

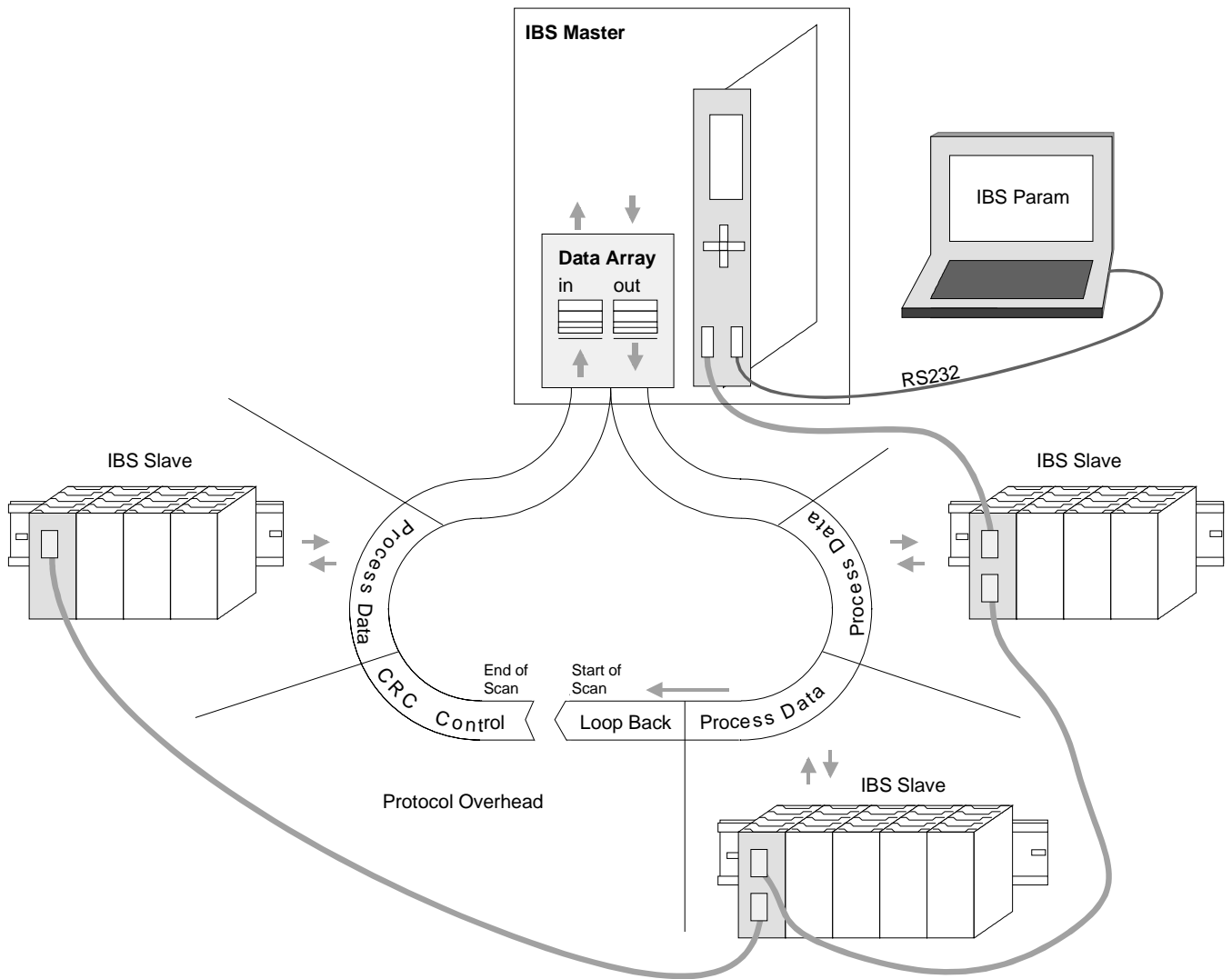

Transfer of control and inspection information

Process data words also contain control and inspection information. This information is only transferred once at the beginning or at the end of the peripheral data of any data cycle. This is why this system is also referred to as a cumulative frame procedure.

Communication principle

The communication principle is independent of the type of data being transferred:

Process data that must be transferred to the periphery is stored in the output buffer of the master in the same sequence as the output stations are connected to the bus. The transfer occurs when the master shifts the "loop-back word" through the ring. Following the loop-back word, all the output data is placed on the bus. This means that the data is shifted through the shift register. The information from the process is returned as input data to the input buffer of the master at the same time as the output data is being sent.

The output data is located at the correct position in the shift registers of the different stations when the entire cumulative frame telegram has been sent and read back again. At this point, the master issues a special control command to the devices on the bus to indicate the end of the data transfer cycle.

When the data check sequence has been processed, output data for the process is transferred from the shift registers. This is stored in the devices connected to the bus and transferred to the respective periphery. At the same time, new information is read from the periphery into the shift registers of the input devices in preparation for the next input cycle. This procedure is repeated on a cyclic basis. This means that the input and output buffers of the master are also updated cyclically. Interbus data communications is therefore full duplex in nature; i.e. both input data and output data are transferred during a single data cycle.

The shift register structure eliminates the need for addresses for every device as is common in other fieldbus systems. The address is defined by the location of the device in the ring.

Deployment with Interbus

Process image

The bus coupler determines the configuration of the installed modules after power on and enters the respective data into the internal process image. This process image is sent to the master. From the process images the master generates a process data list for all couplers connected to the bus. The following two figures show the process data allocation list.

The bus coupler uses the following set of rules to generate the internal process image:

- Digital signals are bit orientated, i.e. each channel is associated with one bit in the process image.
- Separate areas exist for input and output data.
- In the input and output areas non-digital modules are always placed before digital modules.
- The sequence of these allocations depends on the plug-in location starting from the bus coupler.
- Where the data width differs between inputs and outputs the larger of the two determines the data width used by the Interbus coupler. This is always rounded up to a complete word (max. 20Byte).

The following figures are intended to show the allocation of the process data within the Interbus master.

Purely digital periphery

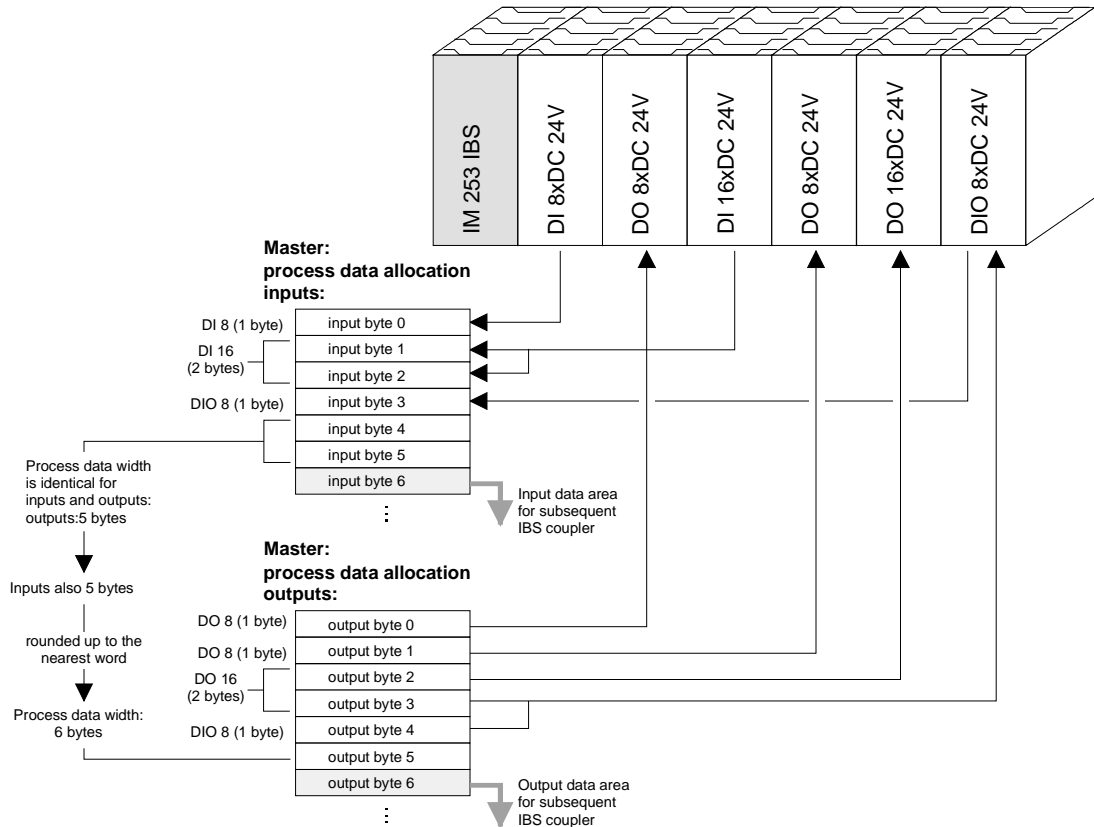

Combination of digital / analog periphery

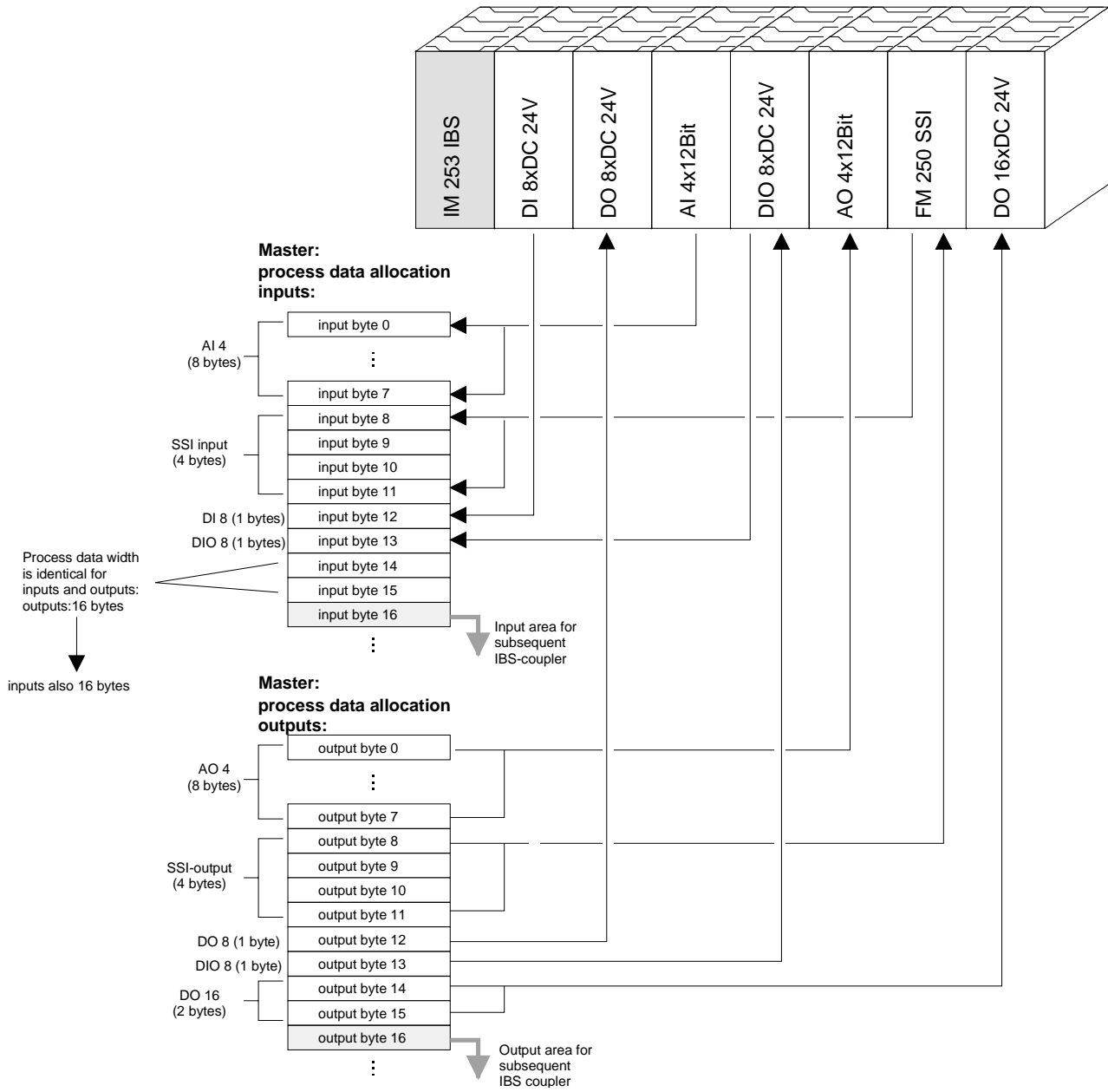

Cyclic process data communications

A process image is employed to exchange input and output data. Communication with digital inputs and outputs is provided by separate data buffers which store the input and output conditions of the modules.

ID code and ID length

During the ID cycle that is executed when the Interbus system is being initialized the different modules connected to the bus identify themselves with their individual functionality and the word length. When the Interbus coupler is turned on, it determines its Interbus length during the initialization phase of the bus modules and generates the respective ID code. Depending on the configuration the Interbus coupler replies with a message identifying it as an analog or a digital remote bus device with variable word length.

Structure of the Interbus ID code

The Interbus ID code consists of 2Byte. The MSB (Byte 2) describes the length of the data words that will be transferred. Where the width of the input and output data differs, the larger value is used for the Interbus data width. The remaining 3Bit are reserved.

When the module is identified by means of the ID code, the master can only be informed of the data width by means of a word. It is for this reason that the data width is always an even number.

The LSB (Byte 1) describes the type of bus module, i.e. the type of signal and other performance criteria like remote bus, peripheral bus module, PCP, ENCOM or DRIVECOM. Bit 1 and 2 determine the direction of the data.

Byte	Bit 7 ... Bit 0
1	Bit 1 ... Bit 0: Direction of data transfer: 00: not used 01: output 10: input 11: input/output Bit 3 ... Bit 2: terminal type Bit 7 ... Bit 4: terminal class The type and class are determined by the Interbus-Club
2	Bit 4 ... Bit 0: Data width 0 to 10 words (binary) Bit 7 ... Bit 5: reserved

Data consistency

Consistent data is the term used for data that belongs together by virtue of its contents. This is the high and the low byte of an analog value (word consistency) as well as the control and status byte along with the respective parameter word for access to the registers.

The data consistency for a station is guaranteed by the Interbus data communication protocol. Synchronous scanning guarantees the consistency of the entire process image. Inconsistencies can arise due to asynchronous accesses to the data areas of the Interbus master from the control CPU. You can find information on secure access methods to the master interface in the respective manuals.

The basic data consistency is only guaranteed for 1Byte. This means that the bits belonging to a single byte were read or written as a single unit. This byte-related consistency suffices when digital signals are being processed. However, when the data length exceeds a byte, for instance for analog values, then the data consistency must be expanded. You must ensure that you transfer consistent data properly from the Interbus master into your PLC.

For further information please refer to the manual for your Interbus master.

Restrictions

You may combine a maximum of 16 input and 16 output modules with an Interbus coupler. The maximum data width for the input and output data is 10 words.

The configuration of the bus coupler or peripheral modules via the Interbus PCP protocol is not supported.

When the bus coupler is being initialized addresses are assigned to the System 200V peripheral module that are used by the bus coupler to communicate with the module under normal operating conditions. It is not possible to remove or insert any module while the system is active. This is due to the fact that addresses are only assigned after a POWER-ON or a RESET and since the data width of Interbus modules must not change while the system is operational.

In accordance with RS422 standards any remote bus segment (= distance between any two stations) may be at distances up to 400m. The maximum total extent of the system is 12.8km.

**Note!**

Before the change is implemented, the respective bus coupler must be powered off. Please ensure that you change the initialization in the master in accordance with the changes to the periphery!

Commissioning

Assembly and integration with Interbus

- Assemble your Interbus coupler using the required modules.
- Configure the Interbus coupler by means of the configuration tool that was supplied with the master.
- Connect the Interbus cable to the coupler and turn the power on.

Initialization phase

During the power-on self-test the bus coupler checks the functionality of its components and communications via the backplane bus. The self-test is active while the PW LED is on. When the test has been completed successfully the RC and BA LEDs are on.

Now the peripheral structure is read in. First the number of modules connected to the bus is determined. Then the modules are identified by means of their type identifier. When the peripheral structure has been registered the location identifiers for the modules are generated. This is then transferred to the modules via the backplane bus. This procedure prepares an internal configuration list that is not externally accessible. These location identifiers provide the basis for directly addressed communications. When an error is recognized, the status of the bus coupler is set to STOP. Once the bus coupler has been initialized properly its status is set to READY.

When an error has been removed, the bus coupler can only be returned to normal operation by switching it off and on.

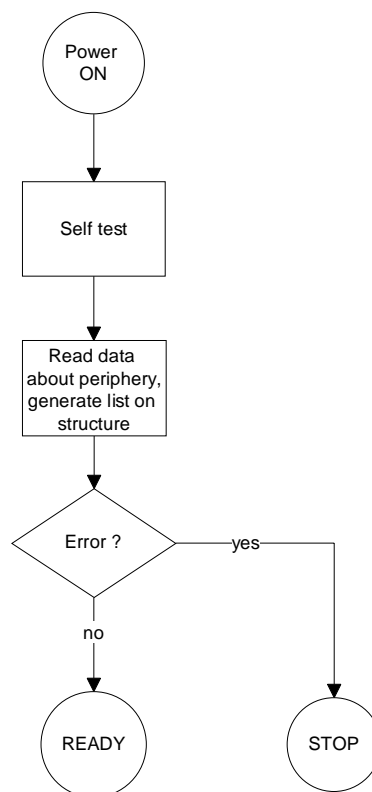

Diagnostic LEDs in an example

The following example shows the reaction of the LEDs to different types of network interruption.

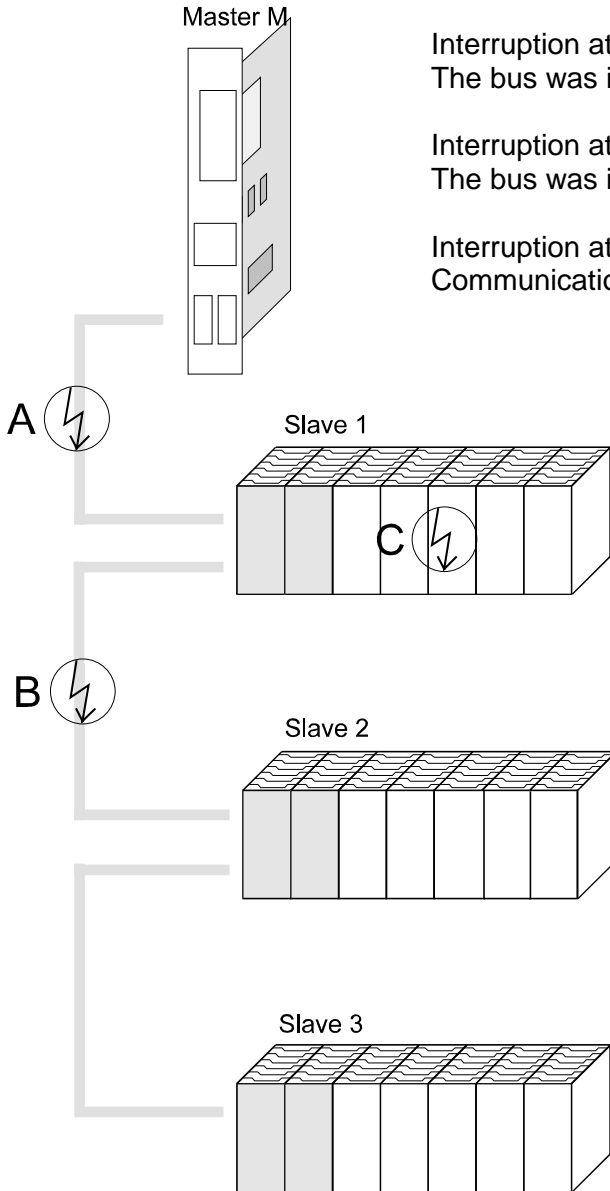

Interruption at position A
The bus was interrupted between the master and slave1.

Interruption at position B
The bus was interrupted between slave1 and slave2

Interruption at position C
Communications via the backplane bus was interrupted.

Slave 1		Interruption at position		
LED		A	B	C
ER		off	off	on
BA		off	off	on
RC		off	on	on
RD		on	on	off

Slave 2		Interruption at position		
LED		A	B	C
ER		off	off	off
BA		off	off	on
RC		off	off	on
RD		on	on	off

Slave 3		Interruption at position		
LED		A	B	C
ER		off	off	off
BA		off	off	on
RC		off	off	on
RD		on	on	on

Configuration of the master

As mentioned before, Interbus generates a data area containing both input and output bytes. The assignment of the modules connected to the bus coupler and the bits and bytes of the process image is provided by the bus coupler.

The Interbus master exchanges a contiguous input and output data block with every Interbus coupler. The data modules of the PLC or the configuration software allocate the bytes contained in this data block to the addresses of the process image.

Master software	Configuration software	Manufacturer
PLC-interfaces version <4	SYS SWT	Phoenix Contact
PLC-interfaces version <4	IBM CMD	Phoenix Contact
PC-interfaces version <3	SYS SWT	Phoenix Contact
general	SYS SWT	Phoenix Contact